

# Me and My Dell



 **NOTE:** A NOTE indicates important information that helps you make better use of your computer.

 **CAUTION:** A CAUTION indicates potential damage to hardware or loss of data if instructions are not followed.

 **WARNING:** A WARNING indicates a potential for property damage, personal injury, or death.

**Copyright © 2014 Dell Inc. All rights reserved.** This product is protected by U.S. and international copyright and intellectual property laws. Dell™ and the Dell logo are trademarks of Dell Inc. in the United States and/or other jurisdictions. All other marks and names mentioned herein may be trademarks of their respective companies.

# Contents

<b>Windows 8.1 Features</b>	<b>12</b>
<b>Signing in</b>	<b>12</b>
Microsoft account	12
Local account	12
<b>Locking and unlocking your computer</b>	<b>12</b>
<b>Accessing the desktop</b>	<b>13</b>
<b>Turning off your computer</b>	<b>13</b>
<b>Start screen and tiles</b>	<b>14</b>
<b>Apps</b>	<b>14</b>
Closing an app	14
Snapping apps	14
<b>More Information</b>	<b>15</b>
<b>Setting Up Your Computer</b>	<b>16</b>
<b>Connecting To The Internet</b>	<b>16</b>
Connecting to the Internet Using LAN	16
Connecting to the Internet Using WLAN	16
Connecting to the Internet Using WWAN	17
<b>Setting up Audio</b>	<b>18</b>
Configuring 5.1/7.1 Audio	18
Connecting 5.1 Speakers	19
Connecting 7.1 Speakers	20
<b>Setting Up Your Printer</b>	<b>21</b>

Setting Up Your Webcam	22
Integrated Webcam	22
External Webcam	22
Setting up Bluetooth	22
<b>About Your Computer</b>	<b>23</b>
<b>Power Adapter</b>	<b>23</b>
<b>Battery</b>	<b>24</b>
<b>Coin-Cell Battery</b>	<b>24</b>
<b>Touchpad</b>	<b>25</b>
<b>Display</b>	<b>25</b>
Touchscreen	25
3D	25
3D Camera	26
<b>Keyboard</b>	<b>26</b>
Physical Keyboard	27
Keyboard Backlight	27
On-Screen Keyboard	28
Keyboard Connection Types	28
Wired	28
Wireless	28
<b>Service Tag and Express-Service Code</b>	<b>29</b>
Locating the Label on Your Computer	29
Dell Support Website	29
BIOS Setup Program	29

<b>Storage Device</b>	<b>30</b>
Internal Storage Devices	30
Removable Storage Devices	30
Optical Drives and Discs	30
Memory Cards	31
<b>Memory Module</b>	<b>33</b>
<b>System Board</b>	<b>34</b>
<b>Chipset</b>	<b>35</b>
<b>Processor</b>	<b>35</b>
<b>Computer Fan</b>	<b>36</b>
<b>Thermal Grease</b>	<b>36</b>
<b>Video Card</b>	<b>37</b>
<b>TV Tuners</b>	<b>38</b>
Internal	38
External	38
<b>Speakers</b>	<b>39</b>
2.1 Audio	39
5.1 Audio	39
7.1 Audio	39
<b>Webcam</b>	<b>40</b>
<b>Network</b>	<b>40</b>
Local Area Network (LAN)	40
Wireless Local Area Network (WLAN)	41
Wireless Wide Area Network (WWAN)	41
Wireless Personal Area Network (WPAN)	41

Modem	42
Router	42
Network-Interface Controller (NIC)	42
Wireless Wide Area Network (WWAN) Adapter	43
Bluetooth	43
Near-Field Communication	43
<b>Using Your Computer</b>	<b>44</b>
<b>Charging the Battery</b>	<b>44</b>
<b>Using your Keyboard</b>	<b>44</b>
Keyboard Shortcuts	44
Keyboard Shortcuts — Windows 8.1/Windows RT	47
Customizing Your Keyboard	48
Changing Keyboard Input Language	49
Using Numeric Keypad on a Laptop	50
<b>Using Your Touchpad</b>	<b>50</b>
Touchpad Gestures	51
Scroll	51
Zoom	52
Rotate	53
Flick	53
Quick Launch	54
<b>Using Your Touchscreen</b>	<b>54</b>
Touchscreen Gestures	54
Zoom	55
Dwell	55
Flick	55
Rotate	56
Scroll	56

<b>Using Bluetooth</b>	<b>57</b>
Pairing a Bluetooth device with your computer	57
<b>Using the Webcam</b>	<b>58</b>
Capturing a Still Image	58
Recording a Video	58
Selecting the Camera and Microphone	58
<b>Ports and Connectors</b>	<b>59</b>
<b>Audio</b>	<b>59</b>
Types of Audio Ports	59
USB	60
USB Ports	60
<b>eSATA</b>	<b>61</b>
<b>Visual Graphics Array (VGA)</b>	<b>62</b>
<b>Digital Visual Interface (DVI)</b>	<b>62</b>
<b>DisplayPort</b>	<b>62</b>
Mini-DisplayPort	62
Advantages of DisplayPort	63
<b>HDMI</b>	<b>63</b>
Advantages of HDMI	63
Mini HDMI	63
Micro HDMI	64
<b>S/DPDIF</b>	<b>64</b>
<b>Software and Applications</b>	<b>65</b>
<b>Computrace</b>	<b>65</b>
Enabling Computrace	66
Getting Help on Computrace	66

<b>My Dell Downloads</b>	<b>66</b>
<b>My Dell</b>	<b>67</b>
Downloading or Upgrading My Dell	67
Accessing My Dell	67
PC Checkup	67
<b>Solution Station</b>	<b>68</b>
Solution Station Offerings	69
<b>Quickset</b>	<b>69</b>
Installing Quickset	70
<b>NVIDIA 3D Applications</b>	<b>70</b>
Playing Games in 3D	70
Keyboard Shortcuts	71
<b>DellConnect</b>	<b>72</b>
<b>Restoring Your Operating System</b>	<b>73</b>
<b>System Recovery Options</b>	<b>73</b>
<b>Dell Backup and Recovery</b>	<b>74</b>
Dell Backup and Recovery Basic	74
Accessing Dell Backup and Recovery	74
Creating System Reinstall Discs	75
Restoring Your Computer	75
Dell Backup and Recovery Premium	75
Upgrading to Dell Backup and Recovery Premium	75
Restoring system data	75
Restoring specific files or folders from a Full System Backup	75
Restoring specific files or folders from a File & Folder Backup	76
Creating a Full System Backup	76



<b>Dell DataSafe Local Backup</b>	<b>76</b>
Dell DataSafe Local Backup	77
Dell DataSafe Local Backup Basic	77
Launching Dell DataSafe Local Backup	77
Creating system reinstall disks	77
Restoring your computer to a previous date or factory settings	77
Dell DataSafe Local Backup Premium	78
Upgrading to Dell DataSafe Local Backup Premium	78
Restoring system data	78
Restoring data using File and Folder Local Backup	78
Restoring specific files or folders from a Full System Backup	78
Restoring specific files or folders from a File & Folder Backup	78
<b>Dell Factory Image Restore</b>	<b>79</b>
Accessing Dell Factory Image Restore	79
Starting Dell Factory Image Restore	80
<b>System Restore</b>	<b>81</b>
Windows 8.1	81
Using System Restore	81
Undoing the Last System Restore	81
Windows 7	82
Using System Restore	82
Undoing the Last System Restore	82
<b>Operating System Disc</b>	<b>83</b>
Reinstalling the Operating System Using the Operating System Disc	83
System Reinstall Discs	83
Restoring Your Computer Using System Reinstall Disc	84

<b>Troubleshooting</b>	<b>85</b>
<b>Basic Troubleshooting Steps</b>	<b>85</b>
<b>Diagnostics</b>	<b>85</b>
Pre-Boot System Assessment	85
Invoking PSA	85
Enhanced PSA	86
LCD BIST	87
Starting LCD BIST	87
Invoking ePSA	88
Beep Codes	89
<b>BIOS</b>	<b>90</b>
<b>Changing BIOS Settings</b>	<b>90</b>
<b>Entering BIOS Setup Program</b>	<b>90</b>
<b>Resetting BIOS Password</b>	<b>91</b>
Remove the CMOS Battery	91
Use System-Board Jumper	91
<b>Changing the Boot Sequence</b>	<b>92</b>
Using Boot Menu	92
Using BIOS Setup Program	92
<b>Getting Help and Contacting Dell</b>	<b>93</b>
<b>Getting Help</b>	<b>93</b>
<b>Contacting Dell</b>	<b>93</b>

<b>References</b>	<b>94</b>
<b>Computer Maintenance</b>	<b>94</b>
<b>Power Management</b>	<b>94</b>
Configuring Power Settings	95
Configuring the Power Button Behavior	96
Improving Battery Life	96
Dell Longevity Mode	97
Dell Desktop Mode	98
<b>Migration Tips</b>	<b>98</b>
Migrating from one Windows Operating System to a newer Operating System	98
<b>Ergonomic Instructions</b>	<b>99</b>
<b>Dell and the Environment</b>	<b>100</b>
<b>Regulatory Compliance Policy</b>	<b>102</b>
Contact Details for Regulatory Compliance Web site	102
Additional Compliance Information	102

# Windows 8.1 Features

---

## Signing in

You can sign in to Windows 8.1 using either a Microsoft account or a local account.

### Microsoft account

 **NOTE:** To sign in using a Microsoft account for the first time, your computer must be connected to the Internet.

Using a Microsoft account synchronizes settings, customizations, and so on, with your Microsoft account and other Windows 8.1 devices that you sign in to using the same email ID. It also associates the email, OneDrive, and other linked accounts with your user profile on the computer. The settings of your computer are backed up in your Microsoft account so that you can restore them if needed.

To sign in using an existing Microsoft account, type the email ID and password.

To create a new Microsoft account, tap or click **Sign up for a new email address** and follow the instructions on the screen.

### Local account

Tap or click **Sign in without a Microsoft account** and follow the instructions on the screen.

## Locking and unlocking your computer

Locking your computer:

1. Access the charms sidebar and tap or click **Start**.
2. Tap or click your account picture in the upper-right corner and then select **Lock**.

Unlocking your computer:

1. Swipe-up from the bottom edge of the screen (or press any key if you are using a keyboard) to dismiss the lock screen.
2. In the log on screen, login to your computer using the method of your choice.

 **NOTE:** To use a different sign-in method, tap or click **Sign-in options** to see the available options.

# Accessing the desktop

To access the desktop interface — like in the previous versions of Windows — tap or click the **Desktop** tile on the **Start** screen.

## Turning off your computer





On the Start screen, click or tap the power icon  → Shut down.

## Charms

Charms provide quick access to the most common tasks such as search, share, settings, and so on. The charms sidebar displays a list of charms available depending on the screen or app that is active. To open the charms sidebar, swipe-in from the right edge of the screen or point your mouse to the upper/lower-right corner of the screen. If you are using a multi-touch touchpad, swipe-in from the right edge of the touchpad.

The most common charms are Search, Share, Start, Devices, and Settings.



	<b>Search</b>	Allows you to find apps, settings, and files on your computer and the internet.
	<b>Share</b>	Allows you to share photos, links, and so on with your friends and social networks.
	<b>Start</b>	Toggles between the Start screen and last used app.
	<b>Devices</b>	Allows you to send files to printers, other computer, and so on. Also allows to send video and audio to supported devices, such as a TV.
	<b>Settings</b>	Provides access to notifications, volume controls, brightness controls, and other computer settings.

# Start screen and tiles

Start screen provides access to apps, friends, files and folders, and so on. You can customize the Start screen by adding, resizing, or removing tiles. You can also move tiles around and group them together.

Some of the tiles are automatically updated and lets you read the news headlines, status updates, and so on.

You can also search from the Start screen by typing the keyword and tapping or pressing the <Enter> key.

## Apps

Apps are programs created specifically to utilize the metro interface of Windows 8.1. Apps run in full-screen mode . These apps are specifically designed for Windows 8.1 interface. Tap or click on the app tile to launch the app.

### Closing an app

- If you are using a touchscreen, drag the app to the bottom of the screen and release the app.
- If you are using a mouse, click and drag the app from the top of the screen to the bottom of the screen and release the app.

### Snapping apps

You can view two apps simultaneously by snapping them together.

To snap apps:

1. Open the two apps.
2. Drag and release one of the apps to the right-side of the screen to dock the app.
3. Drag and release the other app to the left-side of the screen to dock the app.

You may resize the apps by holding the resize button and dragging it.

## More Information

You can get more information on Windows 8.1 and the new features using any of the following resources.

- **Help + Tips** tile
- **dell.com/support**
- **microsoft.com**

# Setting Up Your Computer

---

The setup procedure will vary according to your computer. For setup instructions specific to your computer or tablet, see the *Quick Start Guide* that shipped with your computer or at [dell.com/support](http://dell.com/support).

## Connecting To The Internet

You can connect your computer to the internet using cable, DSL, dial-up, or a WWAN connection. You may also install a wired or wireless router to share your cable or DSL internet connection with multiple devices. Some cable and DSL modems also have built-in wireless routers.

 **NOTE:** Before connecting your computer to the internet using a cable or DSL modem, make sure your broadband modem and router are configured. For information on setting up your modem and router, contact your internet service provider.



## Connecting to the Internet Using LAN

1. Connect the Ethernet cable to the modem or router and to your computer.
2. Check for activity lights on the modem or router, and your computer.  
 **NOTE:** Some computers may not have activity lights.
3. Open your web browser to verify Internet connection.

## Connecting to the Internet Using WLAN

 **NOTE:** Make sure Wi-Fi is enabled on your computer. For more information on enabling wireless on your computer, see the *Quick Start Guide* that shipped with your computer or at [dell.com/support](http://dell.com/support).

## Windows 8.1/Windows RT

1. Make sure that wireless is enabled on your computer or tablet.
2. Select **Settings** in the charms sidebar.
3. Select .
4. Click on the network you want to connect to.
5. Enter the network password, if prompted.  
 **NOTE:** You may have configured the network password while setting up the router or the router may have a default network password. For details, contact the router manufacturer.
6. Turn on/off file sharing (optional).



## Windows 7

1. Make sure that wireless is enabled on your computer or tablet.
2. In the notification area, select .
3. Click on the network you want to connect to.
4. Enter the network password, if prompted.



**NOTE:** You may have configured the network key while setting up the router or the router may have a default network key. For details, contact the router manufacturer.

5. Turn on/off file sharing (optional).

## Connecting to the Internet Using WWAN

WWAN connection does not require a modem or a router to allow your laptop or tablet to connect to the internet. The WWAN card on your computer connects directly to the service provider's network, like your cell phone.

If you purchased a tablet with a network service contract, the internet may already be activated.

## Windows 8.1/Windows RT

1. Make sure that wireless is enabled on your computer or tablet.
2. Select **Settings** in the charms sidebar.
3. Select .
4. Click on the network you want to connect to.

## Windows 7

1. Click **Start** , type `Mobile Broadband Utility` in the search box and press <Enter>.
2. In the Mobile Broadband Utility window, click **Connect**.

## Setting up Audio

Dell laptops and tablets have built-in speakers that support 2-channel audio. To use the built-in speakers, play the media and set the volume to your desired level.

Dell computers and tablets also support a 3.5 mm audio port to allow you to connect external speakers. If you are setting up 2-channel audio, connect the speakers to the 3.5 mm headphone port or the audio port.

Dell desktops may support 5.1/7.1 audio. If you are setting up 5.1/7.1 audio, you must connect the speakers to the appropriate ports for best audio output.

 **NOTE:** For more information on the ports available on your computer or tablet, see the *Specifications* at [dell.com/support](http://dell.com/support).

 **NOTE:** For best results, place the speakers as specified in the documents that shipped with your speakers.

 **NOTE:** On computers with a discrete sound card, connect the speakers to the connectors on the card.



### Configuring 5.1/7.1 Audio

Configure your computer to provide multi-channel audio output.

#### Windows 8.1

1. Access the **Search** charm.
2. Click **Settings** and type **Audio** in the search box.
3. Click **Manage Audio Devices**.
4. Click **Speaker/Headphones**.
5. Click **Next**.
6. Click **Configure** and click **Test**. You should hear a tone from every speaker.
7. Click **Finish**.

#### Windows 7

1. Click **Start** , type **Sound** in the search box and press <Enter>. In the results that appear, click **Sound**. Alternatively, click **Start**  → **Control Panel** → **Hardware and Sound** → **Sound**.
2. Select **Speakers** and click **Configure**.  
The **Speaker Setup** window appears.
3. Select a speaker configuration under **Audio channels:** and click **Test**.  
You should hear a tone from every speaker.
4. Click **Next** and follow the instructions on the screen.

## Connecting 5.1 Speakers

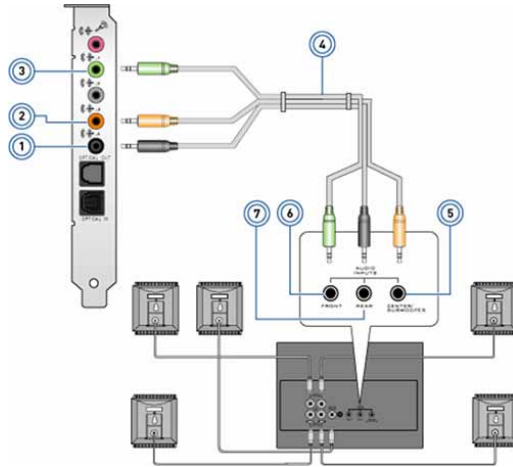

- |   |   |   |  |
|---|---|---|--|
| 1 | Rear audio connector on the computer    | 5 | Center/LFE surround out on the speaker |
| 2 | Center/LFE surround out on the computer | 6 | Front audio connector on the speaker   |
| 3 | Front audio connector on the computer   | 7 | Rear audio connector on the speaker    |
| 4 | 5.1 channel audio cable                 |   |  |

## Connecting 7.1 Speakers

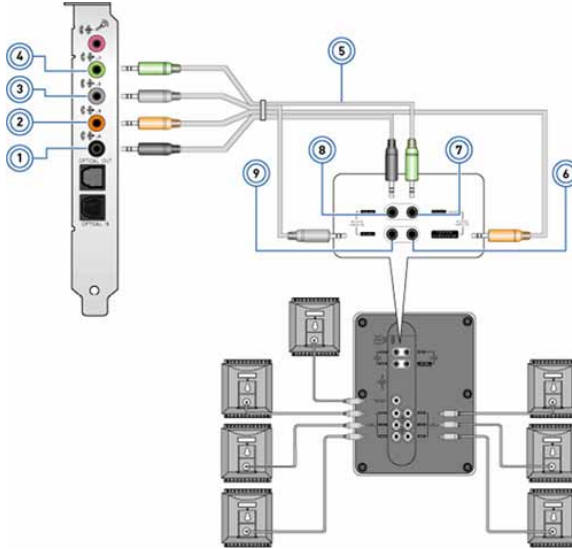

- |   |   |   |  |
|---|---|---|--|
| 1 | Rear audio connector on the computer    | 6 | Center/LFE surround out on the speaker |
| 2 | Center/LFE surround out on the computer | 7 | Front audio connector on the speaker   |
| 3 | Side audio connector on the computer    | 8 | Rear audio connector on the speaker    |
| 4 | Front audio connector on the computer   | 9 | Side audio connector on the speaker    |
| 5 | 7.1 channel audio cable                 |   |  |

## Setting Up Your Printer

You can connect a printer to your computer using USB. Some printers may also support Wi-Fi and Bluetooth connection.

 **NOTE:** The features supported by your printer and the steps to install may vary depending on the printer model. For more information on setting up the printer, see the documentation that is shipped with your printer.

If you are installing a wired printer, connect the printer to your computer using the USB cable before performing these steps. If you are installing a wireless printer, follow the instructions in the documentation of your printer.

### Windows 8.1

1. Access the **Search** charm.
2. Click **Settings** and type *Devices* in the search box.
3. Click **Devices** and follow the instruction on the screen.

 **NOTE:** If your printer is installed, it should appear in the list on the right side. If your printer isn't in this list, click **Add a device** at the top of the device list. Select your printer from this list to install it. For more information on setting up the printer, see the documentation that is shipped with your printer.

### Windows 7

1. Click **Start**  → **Devices and Printers**.
2. Click **Add a Printer**. The **Add Printer Wizard** appears.
3. Follow the instructions in the **Add Printer Wizard**.

 **NOTE:** You may be prompted to install the printer driver while adding your printer. Use the printer-driver media or download the drivers from the printer manufacturer's website. For more information on setting up the printer, see the documentation that is shipped with your printer.

## Setting Up Your Webcam

### Integrated Webcam

The integrated webcam is present on the laptop display or external display. If you order the webcam along with your computer, the drivers and software are installed when you receive your computer. Use the media shipped with the computer only to reinstall them. For more information on using the webcam, see “Using the Webcam”.

### External Webcam

Use the media that is shipped with your webcam to install the drivers and other required software to use all the features of your webcam. For more information, see the documentation that shipped with your webcam.

## Setting up Bluetooth

You can enable Bluetooth on your computer by turning on the wireless. Most laptops and tablets are shipped with a built-in Bluetooth card.

To pair a device with your computer or tablet, see the documentation for your device.

 **NOTE:** To find out if your computer or tablet has an internal Bluetooth card, see the *Specifications* of your computer or tablet at **dell.com/support**.

# About Your Computer

---

## Power Adapter

Power adapters are used to supply power to portable computers and certain desktop computers. The Dell power-adapter kit consists of the power adapter and the power cable. The power-adapter rating (65 W, 90 W, and so on) depends on the computer it is designed for, and the power cable varies based on the country where the power adapter is shipped.

**△ CAUTION: To avoid damaging your computer, it is recommended to use only the power adapter that shipped with your computer or a Dell-approved replacement power adapter.**





# Battery

Batteries are mainly classified by their power ratings, such as 45 WHr, 65 WHr, and so on. The battery allows you to use your device when it is not connected to a power outlet.

The life cycle of the battery is the number of time it can be discharged and recharged without affecting the operating time significantly. After the battery life-cycle reaches its end, you must replace the battery.

Depending on the computer model, the battery on your computer may be user replaceable or may require a Dell service technician to replace.

 **NOTE:** High-capacity batteries generally have a longer life-cycle, since you need to charge high-capacity batteries less often compared to low capacity batteries.

 **NOTE:** For tips on improving the battery life, see [“Improving Battery Life”](#).

## Coin-Cell Battery

Coin-cell battery provides power to the Complementary Metal-Oxide Semiconductor (CMOS) chip while the computer is turned off. The CMOS chip contains the time, date, and other configuration information about your computer.

Under normal usage conditions, the coin-cell battery can last for several years. The factors that affect coin-cell battery life are type of system board, temperature, the time for which the computer is powered off, and so on.





# Touchpad

A touchpad is available on most laptops and provides the functionality of a mouse. It has a touch-sensitive surface that senses the motion and position of your finger(s). You can use the touchpad to move the cursor, drag or move selected items, and click by tapping the surface. Gesture-enabled touchpads support gestures such as zoom, pinch, rotate, scroll, and so on. You can also purchase external touchpads.

 **NOTE:** For information on using the touchpad, see [“Using Your Touchpad”](#).

# Display

Displays are classified based on their screen size, resolution, color gamut, and so on. Generally, a screen with higher resolution and better color support provides better image quality. Some external displays also have USB ports, media-card readers, and so on.

Displays may also support features such as, touchscreen, 3D, and wireless connection.

# Touchscreen

Touchscreen is a display device that lets you interact with the objects on the screen by touching the display instead of using a mouse, touchpad, or a keyboard. You can operate a touchscreen with a finger, or another passive object, such as a stylus. Touchscreens are commonly used in phones, tablets, computers, and so on. Commonly used touchscreen technologies are capacitive touch and resistive touch.

 **NOTE:** Touchscreen may not be supported on all computers.

 **NOTE:** For information on using the touchscreen, see [“Using Your Touchscreen”](#).

# 3D

3D-capable displays can display 3D images and videos. 3D works by presenting separate 2D images to the left and right eye. These images are then combined and interpreted by the brain as one image with depth.

 **NOTE:** You may need specially designed 3D glasses to be able to view 3D images.

## 3D Camera

3D camera allows you to capture and stream three-dimensional images, making it possible to perceive distance, size, dimensions of objects through the built-in sensors. This enables enhanced interactivity during video conferencing, online gaming, and so on.

## Wireless Display

The wireless feature allows you to share your computer display with a compatible TV without the use of cables. To check if your TV supports this feature, see the documentation of the TV.

Minimum requirements for setting up wireless display are:

Processor	Intel Core i3-3xx
Video Controller	Intel HD Graphics
WLAN card	Intel Centrino 6100/6200/6300 or Intel Centrino Advanced-N + WiMAX 6250
Operating System	Windows 7 or higher.
Driver	Latest wireless-card drivers and Intel Wireless Display Connection Manager available at <a href="http://dell.com/support">dell.com/support</a> .

 **NOTE:** Wireless display may not be supported on all computers.

## Keyboard

Keyboards allow you to type characters and perform special functions using shortcut keys. The number of keys and the characters available may differ based on the country where the keyboard is shipped.

Laptops have built-in keyboards. Tablets generally have on-screen keyboards and some tablets also support external keyboards. Dell desktops have an external keyboard connected using USB or wireless signals.

The common keys available on the keyboard are:

- Alphanumeric keys for typing letters, numbers, punctuation, and symbols
- Multimedia and application shortcut keys
- Control keys such as <Ctrl>, <Alt>, <Esc>, and the Windows key
- Shortcut keys to perform specific tasks or to launch specific features
- Function keys, <F1> through <F12>

- Navigation keys for moving the cursor around in documents or windows: <Home>, <End>, <Page Up>, <Page Down>, <Delete>, <Insert>, and arrow keys

## Physical Keyboard

Physical keyboards are used with laptop and desktop computers. Laptops generally have a built-in keyboard. External keyboards are generally used with desktop computers. Some keyboards may have features such as keys for volume adjustment, application shortcuts, built-in touchpad, programmable shortcut keys, backlight, and so on.



## Keyboard Backlight

The backlight present on some physical keyboards illuminates the symbols on the keys to allow for using the keyboard in dark environments. You can turn on the backlight manually or configure the backlight to turn on automatically when your computer is placed in a dark environment.



The backlit keyboard on Dell laptops have different lighting states. Press the <Fn> and the right-arrow key to toggle between the various lighting states.

 **NOTE:** Backlit keyboard may not be available on all computers. To check if backlit keyboard is available on your computer, see the *Specifications* of your computer at [dell.com/support](https://dell.com/support).

## On-Screen Keyboard

On-screen keyboards are available on almost all computers and tablets, however, they are generally used in touchscreen devices such as tablets and all-in-one computers. You can select the keys using a mouse or by touching the keys on a touchscreen.

## Keyboard Connection Types

Keyboards can be connected to your computer with a cable (wired) or using wireless signals (wireless).

### Wired

Wired keyboards are connected to the computer using a cable (generally USB) and do not require additional power source, such as batteries.

### Wireless

Wireless keyboards use Radio Frequency (RF) or Bluetooth (BT) to connect to your computer. This reduces cable clutter and gives you the flexibility to use the keyboard from a more comfortable position within a few meters from the computer. Such keyboards require batteries to operate.

Keyboard that use RF technology usually ship with a receiver that you must connect to your computer. Bluetooth keyboards can pair with your computer's built-in Bluetooth card or an external Bluetooth adapter.

# Service Tag and Express-Service Code

You can find the Service Tag and the Express-Service Code of your computer using one of the following:

- Label on the computer or tablet
- My Dell tile or My Dell software on your computer. For more information, see “My Dell”.
- Dell support website at **dell.com/support**
- BIOS setup program

## Locating the Label on Your Computer

Laptops — Bottom of the laptop (under system badge or in battery bay)

Desktops — Back or top of the computer chassis

Tablets — Back of the tablet

 **NOTE:** For the specific location of the label on your device, see the *Quick Start Guide* that shipped with your computer or at **dell.com/support**.

## Dell Support Website

1. Go to **dell.com/support**.
2. Click **Detect Service Tag** and follow the instructions on the screen.

## BIOS Setup Program

1. Turn on (or restart) your computer.
2. When the DELL logo is displayed, watch for the F2 prompt to appear and then press <F2> immediately to enter BIOS setup program.

 **NOTE:** The F2 prompt stays active only for a short time. If you miss the prompt, wait for your computer to boot up to the desktop, then turn off your computer and try again.

3. Navigate to the **Main** tab and look for **Service Tag**.  
For more information about System Setup, see the *Service Manual* of your computer at **dell.com/support**.

# Storage Device

Storage devices allow you to store data for later use. Storage devices can be internal or external. Most storage devices store data till you manually delete the data. Examples of storage devices are hard-disk drives (HDD), solid-state drives (SSD), optical-disc drives, flash drives, and so on.

## Internal Storage Devices

Internal storage devices are installed within your computer and generally cannot be removed while the computer is turned on. The most common internal storage devices are HDDs and SSDs.

HDDs and SSDs use SATA interface to transfer information. SSDs are also physically similar to HDDs, which makes them compatible with existing computers.

HDDs have disk platters, whereas SSDs have flash memory. This makes SSDs faster, quieter, energy efficient, and shock resistant.

## Removable Storage Devices

Storage devices that you can remove from your computer without turning the computer off are called removable storage devices. Commonly used removable storage devices include:

- Optical discs
- Memory cards
- Flash drives
- External hard drives

## Optical Drives and Discs

Your computer may support a DVD RW or a DVD RW and Blu-ray combo drive. Optical discs can be read-only, write-once, or re-writeable.

Some of the common types of drives are:

- Blu-ray writer — Reads and writes to Blu-ray Discs, DVDs, and CDs.
- Blu-ray reader + DVD RW combo — Reads Blu-ray Discs. Reads and writes to DVDs and CDs.
- DVD RW — Reads and writes DVDs and CDs.

## Memory Cards

Memory cards, also referred to as media or flash cards, use flash memory to store data. They are re-writeable, fast, and retain data even when power supply is cut off. They are commonly used in devices such as digital cameras, mobile phones, media players, gaming consoles, and so on. Your computer may have a media-card reader to read and write to these cards. Some common types of memory cards are:

---

**Secure Digital (SD)/Secure Digital High Capacity (SDHC)**



---

**Secure Digital Extended Capacity (SDXC) [card with Ultra High Speed (UHS)]**



---

**Secure Digital miniSD**



---

**Multimedia Card (MMC)**



---

**MultiMedia Card plus (MMC+)**



---

**Multi Media Card (MMC) Mobile**



---

**RS MMC**



---

Extreme Digital (xD)



---

Memory Stick XC (MSXC)



---

Compact Flash I , II/Compact Flash MD

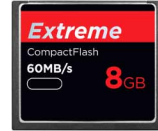

---

Memory Stick Duo



---

Memory Stick Pro Duo



---

Memory Stick Pro-HG Duo



---

Memory Stick (MS)/Memory Stick Pro (MS Pro)



---

Smart Media/Smart Media XD

---





# Memory Module

A memory module stores temporary data that your computer needs to perform tasks. Any file or application loads in the memory modules before you can open or use them. Memory modules are categorized based on their capacity (in GB) and speed (in MHz). Faster and higher amount of memory generally provides better performance. Common memory-module types are:

- Dual In-line Memory Module (DIMM) — Used in desktop computers.
- Small Outline Dual In-line Memory Module (SODIMM) — Smaller in size than DIMMs. Generally used in laptop computers, however, may also be used in some compact desktops and all-in-one computers.



# System Board

A system board forms the central part of computers. All other devices connect to the system board to be able to interact with each other. The system board holds various controllers and connectors that help in exchange of data among various components of the computer. A system board may also have integrated graphics, sound, and network capabilities. Some important components of a system board are:

- Processor socket
- Memory-module connectors
- Expansion-card slots
- CMOS to store the BIOS

The figure below lists the basic components of a desktop system board.

 **NOTE:** Size, shape, and location of components may vary based on the type of system board and the computer it is designed for.

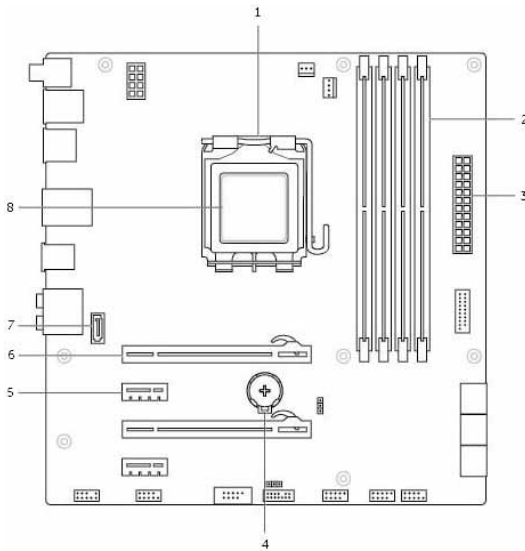

- |   |                          |   |                           |
|---|--------------------------|---|---------------------------|
| 1 | processor socket         | 2 | memory-module connector   |
| 3 | power connector          | 4 | battery socket            |
| 5 | PCI-Express x1 connector | 6 | PCI-Express x16 connector |
| 7 | eSATA connector          | 8 | processor                 |

# Chipset

The chipset controls the components on the system board and allows communication between various components. Generally, the chipset is part of the system board, however, with some new generation processors, the chipset may be integrated in the processor.

# Processor

Processors receive data and instructions from applications and process the data as requested by the software.

Processors are designed specifically for desktops, laptops, mobile devices, and so on. Generally the processor designed for one type of device cannot be used on another type of device.

Processors designed for laptops and mobile devices consume less power compared to the processors designed for desktops or servers.

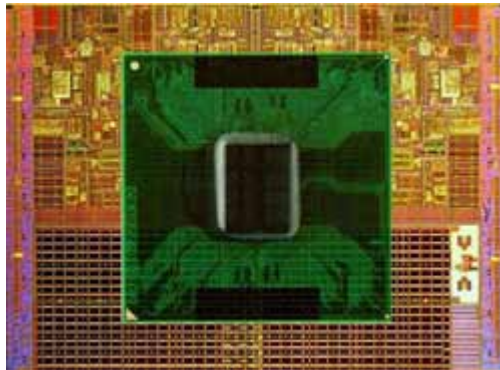

Processors are mainly classified based on:

- Number of processing cores
- Speed or frequency measured in GigaHertz (GHz) or MegaHertz (MHz)
- On-board memory, also referred to as cache

These aspects also determine the performance of the processor.

Higher values generally mean better performance. Some processors may be integrated on the system board.

Some of the processor manufacturers are Intel, AMD, Qualcomm, and so on.

## Computer Fan

A computer fan cools the internal components of a computer by expelling hot air from the computer. Computer fans are commonly used to cool components that have high power consumption and thus generate a high amount of heat. Keeping the components cool helps in protecting them from overheating, malfunctioning, and damage.

## Heat Sink

Heat sinks are used to dissipate heat generated by the processor, some high-end graphics cards and on-board chipsets. Heat sinks generally have a fan mounted above or beside them to increase airflow.

A heat sink is made up of fins or blades instead of a single block of metal. This helps increase the surface area for increased heat dissipation. A layer of thermal grease is applied between the processor/graphics card and the heat sink for easy exchange of heat.



## Thermal Grease

Thermal grease, also called thermal gel or thermal compound, is used to create a heat-inductive layer between a processor and heat sink. Applying thermal grease between the processor and heat sink increases the heat transfer from the processor to the heat sink, as the thermal grease has better conductivity than air.

# Video Card

Video cards process graphics data and send video output to a display device such as a monitor or projector.

Video cards can be of two types:

- **Integrated** — Often referred to as on-board video card, it is integrated on the system board. In some computers, the video card is integrated on the processor. Integrated video cards generally share the system memory (RAM) and they may also utilize the processor to perform video processing.

An Accelerated Processing Unit (APU) is integrated on the same die as the processor and provides higher data transfer rates while reducing the power consumption.

- **Discrete** — Discrete video cards are installed separately on the system board. Discrete video cards have dedicated memory on the cards and generally provide higher performance than integrated video cards. These cards are best suited for graphic intensive applications, high-definition video games, and so on.



**NOTE:** When a discrete video card is installed on a computer that also has an integrated video card, the integrated video card is disabled by default. Use the BIOS setup program to select which card to use.

Switchable graphics allow computers equipped with both a low-power integrated graphics chip, and a high-power discrete graphics card to switch between either cards, depending on the load and requirements.

# TV Tuners

You can use TV tuners to watch television on your computer. TV tuners are available for desktop and laptop computers as internal or external devices.

 **NOTE:** TV Tuners are not supported in all computers.

## Internal

- PCI-E
- PCI

## External

- USB
- PC Card
- ExpressCard



TV tuners are mostly standalone, however, some video cards also have built-in TV tuners.

For more information on using TV tuners, see the documentation for the TV tuner.

# Speakers

Laptops and tablets have built-in speakers for audio output. Desktops also have a built-in speaker, however, they are used only to produce beeps to indicate errors or failures.

You can also connect external speakers to your computer or tablet. Speakers may support 3.5 mm audio connector, USB, or wireless connection to your computer.

Speakers are generally categorized by the number of audio channels they support; 2, 2.1, 5.1, 7.1, and so on. The digit before the decimal point indicates the number of channels and the digit after the decimal indicates the sub-woofer.

 **NOTE:** Your sound card and speakers must support 5.1/7.1 channels for producing 5.1/7.1 channel audio.



## 2.1 Audio

2.1 refers to a system with two speakers (left and right channel) and one subwoofer.

## 5.1 Audio

5.1 refers to the number of audio channels in most surround-sound configurations. A 5.1 audio system uses five main audio channels (front left, front right, center, left surround, and right surround) and one low-frequency audio channel.

## 7.1 Audio

7.1 refers to the number of audio channels in high-end surround-sound configurations. A 7.1 audio system uses two additional speakers (rear left and rear right) in combination with the 5.1 audio system. For more information on setting up audio see [“Setting up Audio”](#).

## Webcam

A webcam allows you to capture videos and photos, and can also be used for video calls. Your display may have a built-in webcam or you can connect external webcam to your computer. Camera quality is mainly defined by the number of pixels it can capture.

To use the webcam, you must install webcam drivers and software. If you ordered the webcam along with your computer, the drivers and software are generally installed when you receive your computer. For more information on using up the webcam, see [“Using the Webcam”](#).

## Network

A network allows you to connect your devices with each other and to the internet. These devices include computers, tablets, phones, printers, and other peripherals. You can set up your network using cables (LAN) or using wireless devices (WLAN). Networks can be set up using Ethernet, Wi-Fi, WWAN, Bluetooth, and so on.

### Local Area Network (LAN)



Devices are connected using Ethernet cables and cover a relatively small area, generally within a house or a building.



## Wireless Local Area Network (WLAN)



Devices are connected wirelessly and cover a relatively small area, generally within a house or a building. The wireless connection used for setting up WLAN is generally Wi-Fi (802.11x).

## Wireless Wide Area Network (WWAN)

Also known as Mobile Broadband, this service is generally provided by the phone companies for use on mobile devices. A mobile device or laptop must support WWAN technology to connect to this network.

## Wireless Personal Area Network (WPAN)

Devices are generally connected wirelessly using Bluetooth, RF, Near-Field Communication (NFC), and so on. This type of network generally operates within a few feet of the devices. To connect your computer or tablet to the Internet, see [“Connecting To The Internet”](#).

## Modem

Modems allow you to connect your computer or router to the internet. Modems can be analog (dial-up) or digital (DSL or Cable). DSL or cable modems are generally provided by your internet service provider.

- Dial-up modem — Electronic devices that convert analog phone signals into digital signals that the computer can process, and digital computer signals into analog signals that can be transmitted over the telephone lines. Dial-up modems can be internal or external.
- Digital modem — Used to send and receive data to and from a digital telephone line, like Digital Subscriber Line (DSL) or Integrated Services Digital Network (ISDN).

## Router

A router is a device that forwards data between computer networks.

The most familiar type of routers are home and small office routers that allow you to share your internet connection between multiple devices at the same time.

Routers can be wired or wireless. A wired router allows you to connect your computer using a Ethernet (RJ45) cable. Most wired home routers have four ports allowing you to connect up to four computer to the internet at the same time. A wireless router uses Wi-Fi technology and allows you to wirelessly connect your phones, tablets, computers, and other devices to the network. Wireless routers can connect to several devices at the same time. For more information, see the documentation for your router.

## Network-Interface Controller (NIC)

Network-Interface Controllers (NIC), also referred to as network adapters or Local-Area Network (LAN) adapters, connect to a network using an Ethernet cable. NICs can be internal (integrated to the system board) or external (expansion cards). Most new computers have integrated network adapters.

## Wireless Local-Area Network (WLAN) Adapter

WLAN adapters use Wi-Fi technology and allow your devices to connect to a wireless router. Your computer may have an internal (expansion cards or integrated to the system board) or an external WLAN adapter.

## Wireless Wide Area Network (WWAN) Adapter

Wireless Wide Area Network (WWAN) controllers allow wireless connectivity through cellular tower technology. This technology is mainly available on phones, tablets, and business-class laptops. A SIM card and a service contract may be required for WWAN connectivity.

## Bluetooth

Bluetooth allows you to connect other Bluetooth-enabled devices to your computer or tablet, over a short distance. Bluetooth devices may include phones, headsets, keyboard, mice, printers, and so on. Bluetooth adapters can be internal (expansion cards or integrated to the system board) or external.

More sophisticated routers, such as enterprise routers, connect large business or ISP networks up to the powerful core routers that forward data at high speed along the optical fiber lines of the Internet backbone.

## Near-Field Communication

Near-Field Communication (NFC) allows you to exchange data between two devices by touching the devices with each other or by bringing them close to each other. You can use NFC-enabled devices to read NFC-tags, make payments, share files between compatible devices, and so on.

On Dell laptops and tablets that support NFC, it is enabled by default when wireless is turned on.

 **NOTE:** For connecting your NFC-enabled device to your computer or tablet, see the documentation for your device.

 **NOTE:** File sharing works only between devices using Windows operating system.

# Using Your Computer

---

## Charging the Battery

Connect the power adapter to your computer or tablet to charge the battery. The battery is charged while the computer or tablet is in use or turned off. The internal circuitry of the battery prevents it from overcharging.

 **NOTE:** If the battery becomes too hot due to being in a hot environment, it may not charge when you connect the power adapter. Allow the battery to cool down for it to resume charging.

 **NOTE:** For steps on improving the battery life of your computer, see ["Improving Battery Life"](#).

## Using your Keyboard

Press the keys on your physical keyboard or tap the characters on the on-screen keyboard to type text and to perform other functions.

### Keyboard Shortcuts

Some keys on the laptop keyboard, and some external keyboards, may perform two or more functions when pressed along with other special keys, such as <Fn>. Some computers allow you to select the default behavior of the key using BIOS setup program or using keyboard shortcuts.

<Ctrl><Shift><Esc>

Open the **Task Manager** window.

<Fn><F8>

Toggle between display devices — main display only, duplicate, extend to both displays, and second display only.

Highlight the desired icon to switch the display to that option.

<Fn> and up-arrow key

Increase brightness on an integrated display.

<Fn> and down-arrow key

Decrease brightness on the integrated display only (not on an external display).

<Fn><Esc>	Activate a power management mode. You can reprogram this keyboard shortcut to activate a different power management mode using the <b>Advanced</b> tab in the <b>Power Options Properties</b> window.
<F2>	Rename the selected item.
<F3>	Search for a file or folder.
<F4>	Display the address bar drop-down in Windows Explorer.
<F5>	Refresh the active window.
<F6>	Cycle through screen elements in a window or on the desktop.
<F10>	Activate the menu bar in the active program.
<Ctrl><c>	Copy a selected item.
<Ctrl><x>	Cut a selected item.
<Ctrl><v>	Paste a selected item.
<Ctrl><z>	Undo an action.
<Ctrl><a>	Select all items in a document or window.
<Ctrl><F4>	Close the active window (in programs that allow you to have multiple documents open simultaneously).
<Ctrl><Alt><Tab>	Use the arrow keys to switch between open items.
<Alt><Tab>	Switch between open applications.
<Alt><Esc>	Cycle through items in the order in which they were opened.
<Delete>	Delete a selected item and move it to the Recycle Bin.
<Shift><Delete>	Delete the selected item without moving it to the Recycle Bin. <b>CAUTION:</b> Files deleted using this method cannot be recovered from the Recycle Bin.

<Ctrl> and right-arrow key	Move the cursor to the beginning of the next word.
<Ctrl> and left-arrow key	Move the cursor to the beginning of the previous word.
<Ctrl> and down-arrow key	Move the cursor to the beginning of the next paragraph.
<Ctrl> and up-arrow key	Move the cursor to the beginning of the previous paragraph.
<Ctrl><Shift> with an arrow key	Select a block of text.
<Shift> with any arrow key	Select more than one item in a window or on the desktop, or select text within a document.
Windows key and <m>	Minimize all open windows.
Windows key and <Shift><m>	Restore all minimized windows. This key combination functions as a toggle to restore minimized windows following the use of the Windows key and <m> combination.
Windows key and <e>	Start Windows Explorer.
Windows key and <r>	Open the <b>Run</b> dialog box.
Windows key and <f>	Open the <b>Search Results</b> dialog box.
Windows key and <Ctrl><f>	Open the <b>Search Results-Computer</b> dialog box (if the computer is connected to a network).
Windows key and <Pause>	Open the <b>System Properties</b> dialog box.

## Keyboard Shortcuts — Windows 8.1/Windows RT

This table provides some keyboard shortcuts specific to Windows 8.1 and Windows RT. These keyboard shortcuts are in addition to the keyboard shortcuts that are already available in earlier versions of the Windows.

Windows key and start typing	Search your computer.
<Ctrl><+>	Zoom in to a large number of items on the screen such as apps pinned on the Start screen.
<Ctrl><->	Zoom out of a large number of items on the screen such as apps pinned on the Start screen.
Windows key and <c>	Open the charms sidebar.
Windows key and <f>	Open the Search charm to search files on your computer.
Windows key and <h>	Open the Search charm.
Windows key and <i>	Open the Settings charm.
Windows key and <j>	Switch between the main app and snapped app.
Windows key and <k>	Open the Devices charm.
Windows key and <o>	Lock the screen orientation (portrait or landscape).
Windows key and <q>	Open the Search charm to search apps on your computer.
Windows key and <w>	Open the Search charm to search computer settings controls on your computer.
Windows key and <z>	Displays the options available in the app.
Windows key and spacebar	Switch input language and keyboard layout.
Windows key, <Ctrl>, and spacebar	Switch to a previously selected input language and keyboard layout.
Windows key and <Tab>	Cycle through open apps (except desktop apps).

Windows key, <Ctrl>, and <Tab>	Cycle through open apps (except desktop apps) and snap them as they are cycled.
Windows key, <Shift>, and <Tab>	Cycle through open apps (except desktop apps) in the reverse order.
Windows key, <Shift>, and <.>	Snap an app to the left.
Windows key and <.>	Snap an app to the right.

 **NOTE:** For special shortcut keys available on your computer, see the *Quick Start Guide* that shipped with your computer or at [dell.com/support](http://dell.com/support).

## Customizing Your Keyboard

You can customize your keyboard as follows:

- Change the time before keyboard characters repeat when you press and hold a key
- Change the speed at which keyboard characters repeat
- Change the cursor blink rate
- Customize key sequences for input languages

To customize your keyboard:

### Windows 8.1

1. Right-click anywhere on the **Start** screen.
2. The **All apps** icon appears at the bottom-right corner of the screen.
3. Under **Windows System**, click **Control Panel**.
4. If your **Control Panel** is displayed by **Category**, click on the **View by:** drop-down menu and select **Small icons** or **Large icons**.
5. Click **Keyboard**.
6. Adjust the keyboard settings you want to change and click **OK** to save the settings and close the window.



## Windows 7

1. Click **Start**  → **Control Panel**.
2. If your **Control Panel** is displayed by **Category**, click on the **View by:** drop-down menu and select **Small icons** or **Large icons**.
3. Click **Keyboard**.
4. Adjust the keyboard settings you want to change and click **OK** to save the settings and close the window.

## Changing Keyboard Input Language

### Windows 8.1

1. Right-click anywhere on the **Start** screen.
2. The **All apps** icon appears at the bottom-right corner of the screen.
3. Under **Windows System**, click **Control Panel**.
4. Click **Clock, Language, and Region**.
5. Under **Language**, click **Change input methods**.
6. Under **Input Method**, click **Add an input method**.
7. Click the language you want to add, then click **Add**.

### Windows 7

1. Click **Start**  → **Control Panel**.
2. If your **Control Panel** is displayed by **Category**, click on the **View by:** drop-down menu and select **Small icons** or **Large icons**.
3. Click **Region and Language**.
4. Under **Keyboards and Languages**, click **Change keyboard...**
5. Under **General**, click **Add...**
6. Click the language you want to add, then click **OK**.

## Using Numeric Keypad on a Laptop

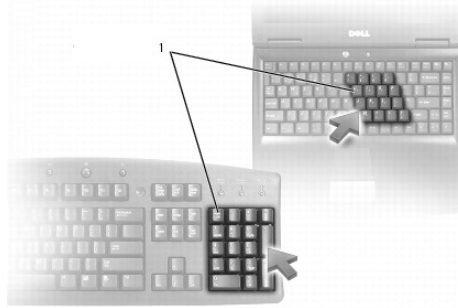

### 1 Numeric Keypad

Your laptop may have a numeric keypad integrated into the keyboard. The keypad corresponds to the keypad of an extended keyboard.

- To type a number or symbol, press and hold <Fn> and press the desired key.
- To enable the numeric keypad, press <Num lock>. The  light indicates that the keypad is active.
- To disable the numeric keypad, press <Num lock> again.

 **NOTE:** Some laptops may have a dedicated numeric keypad.

## Using Your Touchpad

Use the touchpad to move the cursor or select objects on the screen.

- To move the cursor, gently slide your finger over the touchpad.
- To left-click or select an object, press the left touchpad button or tap the touchpad once.
- To right-click an object, tap the right touchpad button once.
- To double-click an object, press the left touchpad button twice or tap twice on the touchpad.
- To select and move (or drag) an object, position the cursor on the object and tap twice quickly on the touchpad without removing your finger from the touchpad after the second tap, then move the selected object by sliding your finger over the surface.

## Touchpad Gestures

 **NOTE:** Some touchpad gestures may not be supported on your computer.

 **NOTE:** You can change the touchpad gestures settings by double-clicking the touchpad icon in the notification area.

Your computer may support **Scroll**, **Zoom**, **Rotate**, **Flick**, and **Quick Launch** gestures.

### Scroll

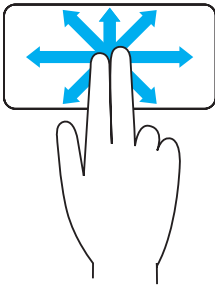

**Pan** — Allows you to move the focus on the selected object when the entire object is not visible.

Move two fingers in the desired direction to pan scroll the selected object.

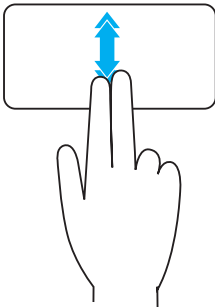

**Vertical Auto-Scroll** — Allows you to scroll up or down on the active window.

Move two fingers up or down at a fast pace to start vertical auto-scroll.

Tap on the touchpad to stop auto-scroll.

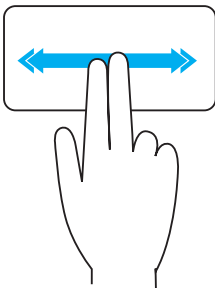

**Horizontal Auto-Scroll** — Allows you to scroll left or right on the active window.

Move two fingers left or right at a fast pace to start horizontal auto-scroll.

Tap on the touchpad to stop auto scrolling.

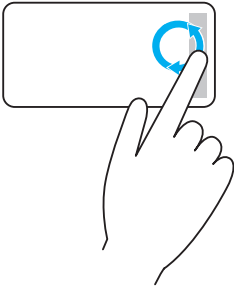

**Circular Scroll Up/Down** — Allows you to scroll up/down.

In the vertical-scroll zone at the right edge of the touchpad, move your finger clockwise to scroll up and counterclockwise to scroll down.

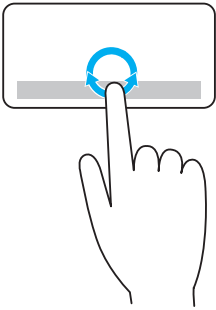

**Circular Scroll Left/Right** — Allows you to scroll left/right.

In the horizontal-scroll zone at the bottom edge of the touchpad, move your finger clockwise to scroll right and counterclockwise to scroll left.

## Zoom

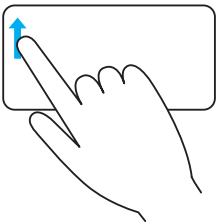

**One-finger zoom** — Allows you to zoom-in or zoom-out by moving one finger in the zoom zone (at the left edge of the touchpad).

Move a finger up in the zoom zone to zoom-in.

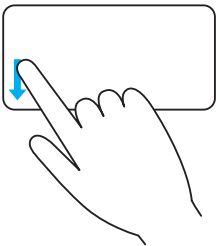

Move a finger down in the zoom zone to zoom-out.

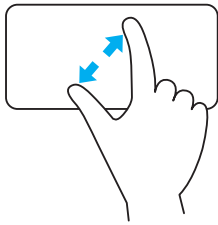

**Two-finger zoom** — Allows you to zoom-in or zoom-out using two fingers.

Place two fingers on the touchpad and then move them apart to zoom-in.

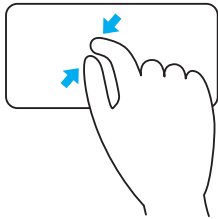

Place two fingers on the touchpad and then bring them closer to zoom-out.

---

## Rotate

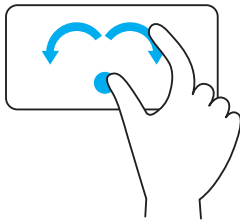

**Twist** — Allows you to rotate active content, in 90-degree increments, using two fingers.

Keeping the thumb in place, move the index finger in an arched direction right or left to rotate the selected item 90-degree clockwise or counterclockwise.

---

## Flick

Allows you to flip content forward or backward.

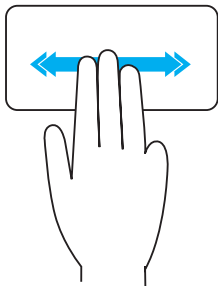

Move three fingers quickly to the left or right to flip content backwards or forward.

## Quick Launch

Allows you to open your favorite applications.

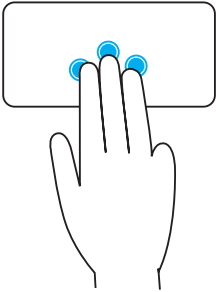

Tap three fingers on the touchpad to launch the pre-configured application.

**NOTE:** Use the touchpad configuration tool to choose the application to be launched.

---

## Using Your Touchscreen

 **NOTE:** Avoid using the touchscreen in dusty, hot, or humid environments.

 **NOTE:** Sudden change in temperature may cause condensation on the inner surface of the screen. This does not affect normal usage and disappears after the computer is kept on for at least 48 hours.

If your computer or tablet has a touchscreen display, you can touch the screen to interact with the items instead of using a mouse or a keyboard.

Some of the basic tasks that you can perform using a touchscreen are open files, folder, and apps, zoom-in, zoom-out, scroll, rotate images, and so on.

You can perform the tasks that you would normally perform using a mouse, such as open files, folders, and applications, scroll using the scroll bar, close and minimize windows using the buttons on the window, and so on.

You can also use the on-screen keyboard using the touchscreen.

## Touchscreen Gestures

Touchscreen gestures enhance the usability of a touchscreen by allowing you to perform tasks like zoom, scroll, rotate, and so on, by sliding or flicking your finger on the display.

 **NOTE:** Some of these gestures are application-specific and may not work in all applications.

## Zoom

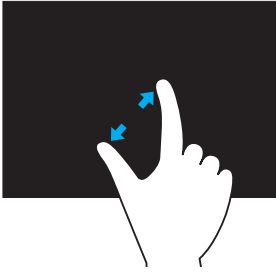

Place two fingers on the touchscreen and then move them apart to zoom-in.

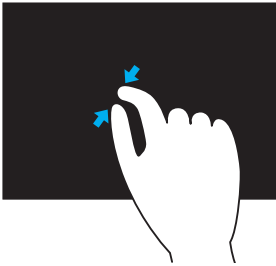

Place two fingers on the touchscreen and then bring them closer to zoom-out.

## Dwell

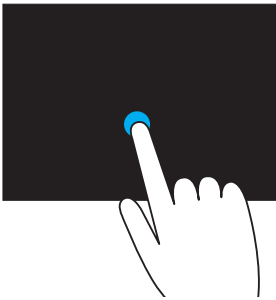

Touch and hold the item on the screen to open the context menu.

## Flick

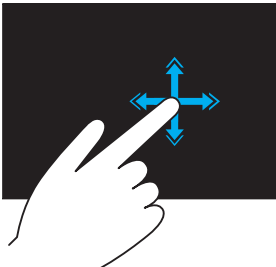

Move a finger quickly in the desired direction to flip through content in the active window like pages in a book.

Flick also works vertically when navigating content such as images or songs in a play-list.

## Rotate

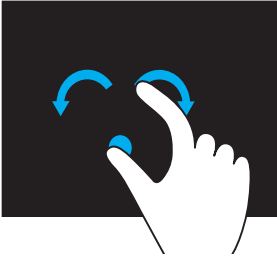

**Rotate clockwise** — Keeping a finger or thumb in place, move the other finger in an arched direction to the right

**Rotate counter-clockwise** — Keeping a finger or thumb in place, move the other finger in an arched direction to the left

You can also rotate the active content by moving both the fingers in a circular motion.

---

## Scroll

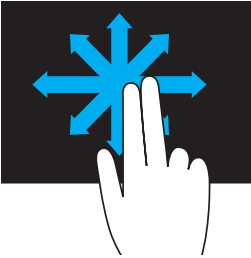

**Pan** – Move the focus on the selected object when the entire object is not visible.

Move two fingers in the desired direction to pan the selected object.

---

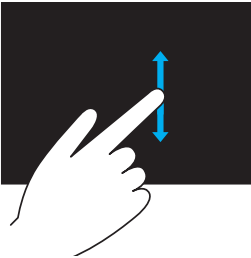

**Scroll Vertical** – Scroll up or scroll down on the active window.

Move a finger up or down to start vertical scrolling.

---

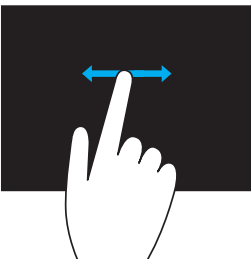

**Scroll Horizontal** – Scroll right or left on the active window.

Move a finger to the right or left to start horizontal scrolling.

---





# Using Bluetooth

You can connect (pair) Bluetooth devices such as mice, keyboard, headsets, phones, TV, and so on. For details on pairing the device with your computer, see the documentation of the device.

 **NOTE:** Make sure that you have Bluetooth drivers installed on your computer.

## Pairing a Bluetooth device with your computer

1. Enable Bluetooth on your computer or tablet and the device you are pairing.  
On a Dell laptop, turn on wireless to enable Bluetooth. For information on turning of Bluetooth on your device, see the documentation for your device.
2. Right-click the Bluetooth icon in the notification area of your taskbar and click **Add a Device**.  
 **NOTE:** If you are unable to locate the Bluetooth icon, click the arrow next to the notification area.
3. In the **Add a device** window, select the device and click **Next**.  
 **NOTE:** If your device is not listed, make sure that your device is discoverable.
4. Follow the instructions on the screen to complete the pairing process.  
 **NOTE:** A passcode may be displayed on your computer and the device.
5. A message confirming the pairing of the device appears once the pairing is complete.

# Using the Webcam

If your computer or display has a built-in webcam, the drivers are installed and configured at the factory. The webcam gets activated automatically when you start a video chat or video capture application.

You can also use Dell Webcam Central (Windows 7 only) to capture still images and videos using the webcam.

## Capturing a Still Image

1. Open Dell Webcam Central.
2. Click on the **Snap Photos** tab.
3. Click on the camera icon  to capture a still image.

 **NOTE:** To configure options such as image size, self-timer, burst-capture, image format, and so on, click on the drop-down arrow next to the camera icon.

## Recording a Video

1. Open Dell Webcam Central.
2. Click on the **Record Videos** tab.
3. Click on the recording icon  to start recording a video.
4. Once you have completed recording the video, click the recording icon again to stop recording.

 **NOTE:** To configure options such as video size, self-timer, time-lapse recording, video quality and so on, click on the drop-down arrow next to the recording icon.

## Selecting the Camera and Microphone

If your computer has multiple webcams or microphones (integrated or external), you can select the webcam and microphone you want to use with Dell Webcam Central.

1. Open Dell Webcam Central.
2. Click the drop-down arrow next to the camera icon at the bottom-left corner of the window.
3. Click the camera you want to use.
4. Click the **Record Videos** tab.
5. Click the drop-down arrow next to the microphone icon  below the preview area.
6. Click the microphone you want to use.

# Ports and Connectors

---

## Audio

Audio connectors allow you to connect speakers, headphones, microphones, sound systems, amplifiers, or TVs audio output.

 **NOTE:** Your computer may not support all the audio ports. For information on the ports available on your computer, see the *Quick Start Guide* that shipped with your computer or *Specifications* at [dell.com/support](http://dell.com/support).

### Types of Audio Ports

---



**Headphone port** — Connect headphones, powered speaker, or sound system.

---



**Microphone port** — Connect external microphone for voice or sound input.

---



**Line-in port** — Connect a recording/playback device such as a cassette player, CD player, or VCR.

---



**Line-out port** — Connect headphones or speakers that have an integrated amplifier.

---



**Rear-surround out port** — Connect multi-channel capable speakers.

---



**Center/LFE surround out** — Connect a single subwoofer. **NOTE:** The Low Frequency Effects (LFE) audio channel, found in digital surround sound audio schemes, carries only frequency information (80 Hz and below). The LFE channel drives a subwoofer to provide extremely low bass extension. Systems not using subwoofers can shunt the LFE information to the main speakers in the surround sound setup.

---



**Side-surround sound port** — Connect left/right speakers.



**RCA S/PDIF port** — Transmits digital audio without the need of analog audio conversion.



**Optical S/PDIF port** — Transmits digital audio, using optical signals, without the need of analog audio conversion.

---

## USB

Universal Serial Bus (USB) allows you to connect peripherals to a computer or a tablet. These peripherals include mouse, keyboard, printer, external drives, cameras, phones, and so on.

USB port may be used to transfer data between your computer and the device and also to charge supported devices. For more information, see the documentation for your device.

Some computers also have USB ports with integrated PowerShare feature that allows you to charge your USB devices even when the computer is turned off.

USB also supports Plug-and-Play and hot swapping.

**Plug-and-Play** — Allows your computer to recognize and configure a device automatically.

**Hot swapping** — Allows you to remove and connect USB devices without restarting your computer.

### USB Ports

**Standard USB** — The standard USB port is present on most laptops and desktops. Most USB devices connect to the computer using this port.

**Mini-USB** — A mini-USB port is used in small electronic devices such as cameras, external storage drives, tablets, and so on.

**Micro-USB** — A micro-USB port is smaller than mini-USB port and is used in phones, tablets, wireless headphones, and other small electronic devices.

**Powered USB** — A powered USB uses a more complex connector than a standard USB. It essentially has two connectors in a single cable, one for standard USB plug and the other for power, thus allowing higher-power devices to be connected without the use of an independent power supply. It is used in retail equipments such as barcode reader and receipt printers.

## USB Standards

**USB 3.0** — This is also referred to as SuperSpeed USB. This port supports data transmission speed of up to 4.8 Gbps and is backward compatible with older USB standards.

**USB 2.0** — Referred to as Hi-Speed USB, it provides additional bandwidth for multimedia and storage applications. USB 2.0 supports data transmission speed up to 480 Mbps.

**USB 1.x** — Legacy USB standard supporting data transfer speeds up to 11 Mbps.

**USB PowerShare** — The USB PowerShare feature allows you to charge USB devices when the computer is powered off or is in sleep state. The  icon indicates that the USB port supports PowerShare feature.

 **NOTE:** Certain USB devices may not charge when the computer is powered off or in sleep state. In such cases, turn on the computer to charge the device.

 **NOTE:** If you turn off your computer while charging a USB device, the device may stop charging. To continue charging, disconnect the device and connect it again.

 **NOTE:** On laptops, PowerShare feature stops charging the device when the laptop battery charge reaches 10%. You can configure this limit using BIOS setup program.

**Debug Port** — The debug port enables a user to run the USB 3.0 ports in USB 2.0 mode temporarily for troubleshooting purposes and also when operating system is reinstalled using a USB optical drive or a flash drive.

## eSATA

eSATA allows you to connect external storage devices, such as hard drives and optical drives, to your computer. It provides the same bandwidth as internal SATA ports.

Your computer may have a standalone eSATA port or an eSATA/USB combo port.

# Visual Graphics Array (VGA)

Visual Graphics Array (VGA) allows you to connect to monitors, projectors, and so on.

You can connect to a HDMI or DVI port using a VGA port by using the VGA to HDMI or VGA to DVI adapters.

# Digital Visual Interface (DVI)

Digital Visual Interface (DVI) allows you to connect your computer to displays such as flat-panel monitors, projectors, and so on.

There are three types of DVI connections:

- **DVI-D (DVI-Digital)** — DVI-D transmits digital video-signals between the video card and the digital display. This provides fast and high-quality video output.
- **DVI-A (DVI-Analog)** — DVI-A transmits analog video-signals to an analog display such as a CRT monitor or an analog LCD monitor.
- **DVI-I (DVI-Integrated)** — DVI-I is an integrated connector that can transmit a digital or an analog signal. This port is more versatile as it can be used in both digital and analog connections.

# DisplayPort

DisplayPort provides digital connection between your computer and display devices such as monitors, projectors, and so on. It supports both video and audio signals. DisplayPort was designed specifically to be used with computer displays.

## Mini-DisplayPort

Mini-DisplayPort is a smaller version of the DisplayPort.

 **NOTE:** DisplayPort and Mini-DisplayPort are compatible with each other but the ports and connectors vary in size. If the port sizes are different, use a converter.

## Advantages of DisplayPort

- Supports high resolutions and high refresh-rates
- Supports 3D transmission
- Supports multiple display-devices simultaneously
- Supports HDCP
- Supports plug-and-play adapters that allow you to connect displays using older connection standards such as DVI, HDMI, and VGA
- DisplayPort cables can extend up to 15 meters (49.21 feet) without requiring signal boosters

## HDMI

High Definition Multimedia Interface (HDMI) provides digital connection between your computer, display devices, and other multi-media devices. It supports both video and audio signals.

HDMI ports are commonly available on computers, TVs, set-top boxes, DVD and Blu-ray players, gaming consoles, and so on.

## Advantages of HDMI

- Supports high resolutions and high refresh-rates
- Supports 3D transmission
- Supports HDCP
- Commonly available in most computers and consumer multi-media devices
- Can be used to set up audio-only, video-only, or an audio and video connection
- Compatible with fixed-pixel displays such as LCDs, plasma displays, and projectors

## Mini HDMI

Mini High Definition Multimedia Interface (HDMI) provides digital connection between your computer and portable devices such as smartphones, laptops, and so on.

## Micro HDMI

Micro High Definition Multimedia Interface (HDMI) provides digital connection between your computer and portable devices such as smart phones, laptops, and so on. This connector resembles the micro-USB connector found on most smartphones.

## S/PDIF

S/PDIF is a standard for transferring audio in digital format. You can use S/PDIF to audio devices such as sound cards, speakers, home theater systems, TVs, and so on. It provides 5.1 audio support.

There are two kinds of S/PDIF connections:

- Optical — Uses optical fiber with TOSLINK connectors
- Coaxial — Uses coaxial cable with RCA connectors



# Software and Applications

---

## Computrace

Computrace allows you to track computers as they change hands or move around an organization, and helps to prevent theft and recover lost or stolen computers.



A Computrace-enabled computer that can access the Internet communicates regularly with the Computrace server to report system information, location, and user identity.

Computrace offers the following packages and features:

Complete	Absolute Track	Plus	Lo/Jack for Laptops
Inventory Assets	Track computer hardware	Locate stolen computers	For home and home office
Secured asset tracking	Centralized lease information	Track leases	Protects against theft
Track stolen computers	Software inventory	Investigate loss	Locates using hidden software
Prevent theft	License compliance	Prevent theft	Recovers within 30 days
Remotely delete data			

 **NOTE:** Computrace may not be supported on all computers.

## Enabling Computrace

1. Turn on (or restart) your computer.
2. When the DELL logo appears, press <F2> immediately to enter BIOS setup program.
  -  **NOTE:** If you wait too long and the operating system logo appears, continue to wait until you see the Windows desktop; then, shut down your computer and try again.
3. Select **Security** tab and then select **Computrace(R)**.
4. Select **Activate** to enable Computrace.
  -  **NOTE:** Once you enable or disable the Computrace option in the BIOS setup program, you will not be able to change this setting in future. This is to prevent an unauthorized changes to this option.

## Getting Help on Computrace

Dell provides help on Computrace through Absolute Software. You can contact Absolute Software for help on installation, configuration, usage, and troubleshooting.

To contact Absolute Software see the Absolute Software website at **absolute.com** or send an email to **techsupport@absolute.com**.

## My Dell Downloads

My Dell Downloads is a software repository that allows you to download and install software that was pre-installed on your computer but did not receive the media for.

 **NOTE:** My Dell Downloads may not be available in all regions.

 **NOTE:** You must register to access My Dell Downloads.

My Dell Downloads allows you to:

- View software originally shipped with the computer.
- Download and install entitled software.
- Change your My Dell Downloads account password.

To register and use My Dell Downloads:

1. Go to **smartsource.dell.com/web**.
2. Follow the instructions on the screen to register your computer.
3. Reinstall the software or create a backup media for future use.

# My Dell

My Dell is a one-stop control panel for system tools and diagnostics. You can use My Dell to find your computer's Service Tag, Express Service Code, system information, warranty status, and so on. It provides access to online tools, Dell technical support links, Dell customer support channels, device manager, network connections, system alerts, performance improvement tips, and links to other Dell tools and diagnostic services.

## Downloading or Upgrading My Dell

To download or upgrade to the latest version of My Dell, go to [dell.com/support](https://dell.com/support).

 **NOTE:** It is recommended to download the software from the Internet when prompted during the installation of My Dell.

## Accessing My Dell

**Windows 8.1** — Tap or click the My Dell icon on the Start screen.

**Windows 7** — Click **Start**  → **All Programs** → **Dell** → **My Dell** → **My Dell**.

## PC Checkup

Use PC Checkup to check your hard-drive usage, run hardware diagnostics, and track the changes made to your computer.

- **Drive Space Manager** — Manage your hard drive using a visual representation of the space consumed by each type of file.
- **Performance and Configuration History** — Monitor system events and changes over time. This utility displays all hardware scans, tests, system changes, critical events, and restoration points of the system.
  - **Detailed System Information** — View detailed information about your hardware and operating system configurations; access copies of your service contracts, warranty information, and warranty renewal options.
  - **Get Help** — View Dell Technical Support options, Customer Support, Tours and Training, Online Tools, Service Manual, Warranty Information, FAQs, and so on.

- **Backup and Recovery** — Access system recovery tools that allow you to:
  - Create a Dell Factory Image Restore file on your computer to restore your computer at a later point.
  - Create a Backup and Recovery media.
- **System Performance Improvement Offers** — Acquire software and hardware solutions that help improve your system performance.

## Solution Station

Solution Station is a one stop shop for premium support services providing computer configuration and maintenance, networking setup and support, home entertainment Installation, and so on.

You can choose from one of the following support categories depending on your needs: **Phone support, On-site support (in-home support), or online services.**

Featured services include a free PC health check to optimize and speed-up your computer, help with common errors and troubleshooting, virus and spyware removal, wireless-network setup, and more. You can also find articles and FAQs on the most common problems and instructions on performing common tasks.

The support categories provide flexible pricing and varying degrees of customer involvement in issue resolution.

## Solution Station Offerings

Type	Offerings
Warranty and ongoing care	Extend warranty or service contact Dell Tech Concierge
Installations and setup	Computer setup Wireless-network setup Software installation Windows operating-system installation Internal-hardware upgrades TV and home theater installation Antivirus installation Internet and email setup Computer-accessories setup Internet parental control setup File transfer and data backup
Troubleshooting and repair	Speed up your computer Virus and spyware removal Data recovery Computer errors and troubleshooting Network errors and troubleshooting

## Quickset

Quickset is a suite of software applications that provide enhanced functionality to your Dell computer. It provides easy access to a number of functions that would normally require several steps. Some of the features that you can access using Dell Quickset include:

- Configure wireless shortcut key
- Disable or enable battery charging
- Change Fn-key behaviour

 **NOTE:** Quickset may not be supported on all computers.

## Installing Quickset

Quickset is pre-installed on a new Dell computer. If you need to reinstall Quickset, download it from the Dell support website at [dell.com/support](http://dell.com/support).

 **NOTE:** If you restore your computer using PC Restore or a similar application, Quickset is restored as well.

## NVIDIA 3D Applications

The NVIDIA 3DTV Play application installed on your computer allows you to play 3D games, watch Blu-ray 3D videos, and browse 3D photos. It supports the same games as NVIDIA 3D Vision. For a list of supported 3D games, see [nvidia.com](http://nvidia.com).

 **NOTE:** Refer to NVIDIA support for more details on this application.

 **NOTE:** NVIDIA 3D application is not available on all computers.

### Playing Games in 3D

1. Launch the game in full-screen mode.
2. If you see a message stating that the current mode is not HDMI 1.4 compatible, set the in-game resolution to 1280 x 720 (720p) in HD 3D mode.

## Keyboard Shortcuts

The following are some of the keyboard shortcuts available for 3D gaming:

Keys	Description	Function
<Ctrl><t>	Shows/hides stereoscopic 3D effects	Turns 3DTV Play on or off. <b>NOTE:</b> The gaming performance may reduce when using HD 3D mode even if 3DTV Play is disabled. To maximize performance, select HD or SD mode when 3DTV Play is disabled.
<Ctrl><F4>	Increases 3D depth	Increases the 3D depth in the current game.
<Ctrl><F3>	Decreases 3D depth	Decreases the 3D depth in the current game.
<Ctrl><F11>		Captures a 3D screenshot of the current game, and saves the file in a folder in the <b>Documents</b> folder. To view the file, use the NVIDIA 3D Photo Viewer.
<Ctrl><Alt><Insert>	Shows/hides in-game compatibility message	Displays the NVIDIA recommended settings for the current game.
<Ctrl><F6>	Increases convergence	Moves objects towards you; maximum convergence places all objects in front of the scene in your space; also used to place the laser sight.
<Ctrl><F5>	Decreases convergence	Moves objects away from you; minimum convergence places all objects behind the scene in your space; also used to place the laser sight.

 **NOTE:** For more information, see the NVIDIA application help file.

# DellConnect

DellConnect is an online tool that allows a Dell agent to access your computer (under your supervision) to remotely diagnose and resolve issues on your computer. It allows a technical support representative to interact with your computer with your permission.

A DellConnect request is initiated by a technical support agent when required during troubleshooting.

 **NOTE:** To access DellConnect and terms of usage, see [dell.com/DellConnect](https://dell.com/DellConnect).



# Restoring Your Operating System

---

## System Recovery Options

You can restore the operating system on your computer using one of the following options:

△ **CAUTION: Using Dell Factory Image Restore or the *Operating System* disc permanently deletes all files on your computer. If possible, backup your data files before using these options.**

Option	Description
Dell Backup and Recovery	Use this as the first solution to recover your operating system.
System reinstall discs	Use when operating system failure prevents the use of Dell Backup and Recovery or when installing Windows on a new or replacement hard drive.
System Restore	Use this to restore your operating system configuration to an earlier point in time without affecting your files.
Dell Factory Image Restore	Use this as the last option to restore your operating system. Using this method deletes all files and applications that you might have saved or installed after you received the computer.
Dell DataSafe Local Backup (Windows 7)	Use this when System Restore does not resolve your problem.
Operating System disc (Windows 7)	Use this to reinstall only the operating system on your computer.

# Dell Backup and Recovery

 **NOTE:** Dell Backup and Recovery option is available only in Windows 8.1.

Dell Backup and Recovery has two versions:

- Dell Backup and Recovery Basic
- Dell Backup and Recovery Premium

Features	Basic	Premium
Restore your system back to factory state	✓	✓
Backup files manually	✓	✓
Restore files from backup	✓	✓
Backup and restore to and from the Cloud (You must purchase a cloud storage subscription to use this feature after 30 days)	✓	✓
Continuously backup files to minimize data loss	X	✓
Create a full system backup (including applications and settings)	X	✓
Merge multiple backups and archive old backups	X	✓
Backup and restore files based on type	X	✓

## Dell Backup and Recovery Basic

### Accessing Dell Backup and Recovery

1. Turn on your computer.
2. Access the Search charm.
3. Click **Apps** and type `Dell Backup and Recovery` in the search box.
4. Click **Dell Backup and Recovery** in the search result list.

## Creating System Reinstall Discs

1. Launch Dell Backup and Recovery.
2. Click **Bootable Backup** tile.
3. Click **Factory Backup**.
4. Select **USB Flash Drive** or **Discs**, and then click **Continue**.
5. Follow the instructions on the screen.

## Restoring Your Computer

1. Launch Dell Backup and Recovery.
2. Click the **Recovery** tile.
3. Click **System Recovery**.
4. Click **Yes, Continue**.
5. Follow the instructions on the screen.

## Dell Backup and Recovery Premium

△ **CAUTION:** Although you are provided with an option to preserve your personal files during the recovery process, it is recommended that you backup your personal files on a separate drive or disk before using the recovery option.

✎ **NOTE:** If you ordered Dell Backup and Recovery Premium with your computer through Digital Delivery application, you need to download the Dell Backup and Recovery Basic first to get the Dell Backup and Recovery Premium option.

## Upgrading to Dell Backup and Recovery Premium

1. Launch Dell Backup and Recovery.
2. Click the **Backup** tile and select **Data Backup**.
3. Click **Upgrade to Dell Backup and Recovery Premium**.

## Restoring system data

1. Launch Dell Backup and Recovery.
2. Click the **Backup** tile and select **System Backup**.
3. Follow the instructions on the screen.

## Restoring specific files or folders from a Full System Backup

1. Launch Dell Backup and Recovery.
2. Click the **Recovery** tile, and then select **Data Recovery**.

3. Click **Yes, Continue**.
4. Follow the instructions on the screen.

### Restoring specific files or folders from a File & Folder Backup

1. Launch Dell Backup and Recovery.
2. Click the **Recovery** tile, and then select **Data Recovery**.
3. Click **Yes, Continue**.
4. Type the name of the file or folder in the search box or select the type of data to restore.
5. Follow the instructions on the screen.

### Creating a Full System Backup

1. Launch Dell Backup and Recovery.
2. Click the **Recovery** tile, and then select **System Recovery**.
3. Click **Yes, Continue**.
4. Follow the instructions on the screen.

## Dell DataSafe Local Backup

⚠ **CAUTION:** Using Dell DataSafe Local Backup permanently removes any programs or drivers installed after you received your computer. Before using Dell DataSafe Local Backup, prepare backup media of applications you need to install on your computer. Use Dell DataSafe Local Backup only if System Restore did not resolve your operating system problem.

⚠ **CAUTION:** Although Dell DataSafe Local Backup is designed to preserve the data on your computer, it is recommended that you backup your data before using the Dell DataSafe Local Backup.

 **NOTE:** Dell DataSafe Local Backup may not be available in all regions.

 **NOTE:** Dell DataSafe Local Backup is available only in Windows 7.

 **NOTE:** If Dell DataSafe Local Backup is not available on your computer, use Dell Factory Image Restore to restore your operating system.

Dell DataSafe Local Backup has two versions:

- Dell DataSafe Local Backup Basic
- Dell DataSafe Local Backup Premium

## Dell DataSafe Local Backup

Features	Basic	Premium
Restore your system back to factory state	✓	✓
Create system reinstall disks on DVD or USB media	✓	✓
Full system backup and restore to a previously saved point in time	X	✓
File and folder backup and restore to a previously saved point in time	X	✓
Backup and restore based on the file types (mp3, jpg, and so on)	X	✓
Backup data to a local storage device	X	✓
Automated scheduled backups	X	✓

## Dell DataSafe Local Backup Basic

 **NOTE:** Dell DataSafe Local Backup is available only in Windows 7.

### Launching Dell DataSafe Local Backup

1. Turn on your computer.
2. Click **Start**  → **All Programs** → **Dell DataSafe** → **Dell DataSafe Local Backup**.

### Creating system reinstall disks

1. Launch Dell DataSafe Local Backup.
2. Click **Backup** → **Create Recovery Media**.
3. Follow the instructions on the screen.

### Restoring your computer to a previous date or factory settings

1. Launch Dell DataSafe Local Backup.
2. Click **Restore** → **Restore your entire system to a previous date or to the factory state**.
3. Follow the instructions on the screen.

## Dell DataSafe Local Backup Premium

 **NOTE:** If you ordered Dell DataSafe Local Backup Premium at the time of purchase, it may be pre-installed on your computer.

### Upgrading to Dell DataSafe Local Backup Premium

1. Launch Dell DataSafe Local Backup.
2. Click **UPGRADE NOW!**

### Restoring system data

1. Launch Dell DataSafe Local Backup.
2. Click **Backup**→ **Full System Backup**.
3. Follow the instructions on the screen.

### Restoring data using File and Folder Local Backup

1. Launch Dell DataSafe Local Backup.
2. Click **Backup**→ **File & Folder Local Backup**.
3. Follow the instructions on the screen.

### Restoring specific files or folders from a Full System Backup

1. Launch Dell DataSafe Local Backup.
2. Click **Restore**→ **Restore specific files or folders from a Full System Backup**.
3. Follow the instructions on the screen.

### Restoring specific files or folders from a File & Folder Backup

1. Launch Dell DataSafe Local Backup.
2. Click **Restore**→ **Restore specific files or folders from a File & Folder Backup**.
3. Follow the instructions on the screen.

# Dell Factory Image Restore

**△ CAUTION:** Using the Dell Factory Image Restore option permanently removes any programs or drivers installed after you received your computer. Prepare backup media of applications you need to reinstall before using Dell Factory Image Restore.

**✎ NOTE:** Dell Factory Image Restore may not be available in certain countries or on certain computers.

Use Dell Factory Image Restore only as the last method to restore your operating system. This option restores the software on your hard drive to the state it was initially shipped. Any programs or files added after you received your computer — including data files such as pictures, music, and videos — are permanently deleted.

## Accessing Dell Factory Image Restore

**△ CAUTION:** Using Dell Factory Image Restore permanently deletes all data on the hard drive and removes any programs or drivers installed after you received your computer. If possible, back up the data before performing Dell Factory Image Restore. Use Dell Factory Image Restore only if other recovery methods fail.

After two failed attempts to boot the operating system, the boot sequence automatically attempts to perform system recovery options and perform an automatic repair.

## Starting Dell Factory Image Restore

△ **CAUTION:** Using Dell Factory Image Restore permanently deletes all data on the hard drive and removes any programs or drivers installed after you received your computer. If possible, back up the data before performing Dell Factory Image Restore. Use Dell Factory Image Restore only if System Restore did not resolve your operating system problem.

1. Turn on or restart the computer.
2. When the DELL logo appears, press <F8> few times to access the **Advanced Boot Options** window.
  - ✎ **NOTE:** If you wait too long and the operating system logo appears, continue to wait until you see the Microsoft Windows desktop; then, reboot your computer and try again.
3. Select **Repair Your Computer**. The **System Recovery Options** window appears.
4. Select a keyboard layout and click **Next**.
5. Log on to a local computer.
6. Select **Dell Factory Image Restore** or **Dell Factory Tools**→ **Dell Factory Image Restore** (depending on the configuration of your computer).
7. Click **Next**. The **Confirm Data Deletion** screen appears.
  - ✎ **NOTE:** If you do not want to proceed with Dell Factory Image Restore, click **Cancel**.
8. Select the check box to confirm that you want to continue reformatting the hard drive and restoring the system software to the factory condition, then click **Next**. The restore process begins and may take 20 or more minutes to complete.
9. When the restore operation is complete, click **Finish** to restart the computer.



# System Restore

 **CAUTION:** Backup data files regularly. System Restore does not monitor or recover your data files.

System Restore is a Microsoft Windows tool that helps you undo software changes to your computer without affecting your personal files like documents, photos, emails, and so on.

Every time you install a software or device driver, your computer updates Windows system files to support the new software or device. Sometimes, this may cause some unexpected errors. System Restore helps you restore the Windows system files to the state prior to the installation of the software or device driver.

System restore creates and saves restore points at regular intervals. You use these restore points (or create your own restore points) to restore your computer's system files to an earlier state.

Use system restore if changes to software, drivers or other system settings have left your computer in an undesirable operating state.

 **NOTE:** If newly installed hardware may be a cause, remove or disconnect the hardware and try a system restore.

 **NOTE:** System restore does not backup your personal files and hence it cannot recover your personal files that are deleted or damaged.

## Windows 8.1

### Using System Restore

1. Open the Search charm and click **Settings**.
2. Click **Recovery** and click **Open System Restore**.
3. Follow the instructions on the screen.

### Undoing the Last System Restore

1. Switch to the traditional Windows desktop.
2. Open the Settings charm.
3. Click **Control Panel**.
4. Click **System and Security** and click **Action Center**.
5. At the lower-right corner of Action Center window, click **Recovery**.
6. Click **Open System Restore** and follow the instructions on the screen to undo the last system restore.

## Windows 7

### Using System Restore

1. Click **Start** .
2. In the search box, type System Restore and press <Enter>.

 **NOTE:** The User Account Control window may appear. If you are an administrator on the computer, click **Continue**; otherwise, contact the administrator of the computer.

3. Click **Next** and follow the instructions on the screen.

### Undoing the Last System Restore

In the event that System Restore did not resolve the issue, you may undo the last system restore.

 **NOTE:** Before you undo the last system restore, save and close all open files and exit any open programs. Do not alter, open, or delete any files or programs until the system restoration is complete.

1. Click Start .
2. In the search box, type System Restore and press <Enter>.
3. Click **Undo my last restoration**, click **Next** and follow the instructions on the screen.

# Operating System Disc

 **CAUTION:** Reinstalling the operating system using the operating system disc permanently deletes all data and software from your computer.

 **NOTE:** The Operating System disc is optional and may not ship with your computer.

You can use the Operating System disc to install or reinstall the operating system on your computer. You must reinstall all drivers and software after reinstalling the operating system using the Operating System disc.

## Reinstalling the Operating System Using the Operating System Disc

To reinstall the operating system:

1. Insert the operating system disc and restart the computer.
2. When the DELL logo appears, press <F12> immediately to access the boot menu.

 **NOTE:** If you wait too long and the operating system logo appears, continue to wait until your computer loads the operating system; then, restart your computer and try again.

3. Select the CD/DVD drive from the list and press <Enter>.
4. Follow the instructions on the screen.

## System Reinstall Discs

The system reinstall discs created using Dell Backup and Recovery allows you to return your hard drive to the operating state it was in when you purchased the computer while preserving the data files on your computer. Use Dell Backup and Recovery to create the system reinstall discs.

## Restoring Your Computer Using System Reinstall Disc

To restore your computer using the system reinstall disc:

1. Turn off your computer.
2. Insert the system recovery disc into the optical drive or connect the USB key and power on the computer.
3. When the DELL logo appears, press <F12> immediately to access the boot menu.
  -  **NOTE:** If you wait too long and the operating system logo appears, continue to wait until your computer loads the operating system; then, restart your computer and try again
4. Highlight the media you are using to restore, and press <Enter>.
5. If prompted, quickly press any key to boot from the boot device.
6. Follow the instructions on the screen to complete the recovery process.

# Troubleshooting

---

## Basic Troubleshooting Steps

This section lists some basic troubleshooting steps you can use to resolve common issues with your computer.

- Make sure your computer is switched on and all the components are receiving power.
- Make sure all the cables are firmly connected to the respective ports.
- Make sure that the cables are not damaged or frayed.
- Make sure that there are no bent or broken pins on the connectors.
- Restart your computer and check whether the problem persists.
- For internet connection issues, unplug your modem and router from the electrical outlet, wait for about 30 seconds, plug in the power cables, and try connecting again.

 **NOTE:** For more information on troubleshooting, solutions to common problems, and FAQs, see [dell.com/support](https://www.dell.com/support). To contact Dell for technical support, see “[Contacting Dell](#)”.

## Diagnostics

Your computer has built-in diagnostic tools to help you determine the issue with you computer. These tools may notify you of a problem using error messages, light codes, or beep codes.

### Pre-Boot System Assessment

You can use the Pre-Boot System Assessment (PSA) to diagnose various hardware problems. The ePSA tests devices such as the system board, keyboard, display, memory, hard drive, and so on.

 **NOTE:** PSA may not be supported on all computers.

### Invoking PSA

1. Turn on or restart your computer.
2. Press <F12> at the Dell logo to access the Boot Menu.

 **NOTE:** If you wait too long and the operating system logo appears, continue to wait until you see the Windows desktop, then restart your computer and try again.

3. Select **Diagnostics** and press <Enter>.

4. Follow the instructions on the screen to complete the test.

If a component fails the test, the test stops, the computer beeps, and an error code is displayed. Note the error code(s) and search for solutions at [dell.com/support](http://dell.com/support) or contact Dell.

Follow the instructions on the screen to continue to the next test, retest the component that failed, or stop the test and restart the computer.

If the PSA completes successfully, the following message appears on your screen: " No problems have been found with this system so far. Do you want to run the remaining memory tests? This will take about 30 minutes or more. Do you want to continue? (Recommended) ." Press <y> to continue if you are experiencing memory issue, otherwise press <n> to finish the test.

 **NOTE:** Press <Esc> anytime during the test to abort testing and restart your computer.

## Enhanced PSA

You can use the Enhanced Pre-Boot System Assessment (ePSA) to diagnose various hardware problems. The ePSA tests devices such as the system board, keyboard, display, memory, hard drive, and so on.

 **NOTE:** ePSA may not be supported on all computers.

The ePSA home screen is divided into three areas:

- Devices window — Appears on the left of the ePSA home screen. It displays all the devices in your computer and can be used to select devices.
- Control window — Appears at the bottom-right of the ePSA home screen.
  - Selecting the **Thorough Test Mode** check-box in the control window maximizes the extent and duration of the tests.
  - Status bar appears at the bottom-left side of the control window and indicates the overall completion of the tests.
  - To test selected devices, click **Run Tests**.
  - To exit the ePSA and restart your computer, click **Exit**.
- Status window — Appears on the right of the ePSA home screen.

The status area has four tabs:

- **Configuration** — Displays detailed configuration and status information about all devices that can be tested using ePSA.
- **Results** — Displays all tests that are executed, their activity, and results for each test.
- **System Health** — Displays the status of the battery, power adapter, fans, and so on.
- **Event Log** — Provides detailed information about all tests. The **Stat** column displays the status of the tests.

## LCD BIST

LCD BIST (Built-In Self Test) helps you determine if a display problem is caused by the LCD or some other part. The test may display different colors and text on the screen and if you do not notice the problem during the test then the issue lies outside of the LCD.

 **NOTE:** Peripherals may have diagnostics specific to them. For more information, see the documentation of the peripheral.

### Starting LCD BIST

1. Turn on or restart your computer.
2. Press <F12> at the Dell logo to access the Boot Menu.  
 **NOTE:** If you wait too long and the operating system logo appears, continue to wait until you see the Windows desktop, then restart your computer and try again.
3. Select **Diagnostics** and press <Enter>.
4. If you do not see colored lines on the screen, press <N> to enter the LCD BIST.

## Invoking ePSA

To invoke ePSA:

1. Restart the computer.
2. Press <F12> at the Dell logo to access the Boot Menu.
  -  **NOTE:** If you wait too long and the operating system logo appears, continue to wait until you see the Windows desktop, then restart your computer and try again.
3. Select **Diagnostics** and press <Enter>.
4. Follow the instructions on the screen to complete the test and note any error messages that appear.

If a component fails the test, the test stops, the computer beeps, and an error code is displayed. Note the error code(s) and search for solutions at [dell.com/support](http://dell.com/support) or contact Dell.

Follow the instructions on the screen to continue to the next test, retest the component that failed, or stop the test and restart the computer.

If the PSA completes successfully, the following message appears on your screen: " No problems have been found with this system so far. Do you want to run the remaining memory tests? This will take about 30 minutes or more. Do you want to continue? (Recommended) ." Press <y> to continue if you are experiencing memory issue, otherwise press <n> to finish the test.

If the ePSA completes with errors, the following message appears on your screen: "Testing completed. One or more errors were detected."

The **Event Log** tab in the **Status** window displays the errors that occurred during the ePSA tests.



## Beep Codes

Your computer may emit a series of beeps during start-up if there are errors or problems. This series of beeps, called a beep code, identifies a problem. If this occurs, note the beep code and contact Dell for assistance.

 **NOTE:** Some of the beep codes mentioned in the table below may not apply to your computer.

Beep Codes	Possible Problem
One	Possible system board failure — BIOS ROM checksum failure
Two	No RAM detected <b>NOTE:</b> If you installed or replaced the memory module, ensure that the memory module is seated properly.
Three	Possible system board failure — Chipset error
Four	RAM read/write failure
Five	Real-Time Clock failure
Six	Video card or video controller failure
Seven	Processor failure <b>NOTE:</b> This beep code is supported for computers with Intel processor only.
Eight	Display failure

# BIOS

---

BIOS stores hardware information about your computer and passes on the information to the operating system when the computer boots up. You can make changes to the basic hardware settings stored in the BIOS using BIOS setup program.

You can use BIOS setup program to:

- Set or change a user-selectable option such as the user password.
- Determine the devices installed on your computer, such as amount of memory, type of hard drive, and so on.
- Change the system configuration information after you add, change, or remove any hardware in your computer.

## Changing BIOS Settings

 **CAUTION: Incorrect settings in BIOS setup program may cause your computer to not boot, work incorrectly, or damage your computer.**

You may need to change settings such as date and time, boot devices and boot sequence, enable or disable PowerShare, and so on. To change the settings, enter BIOS setup program, locate the setting that you want to change, and follow the instructions on the screen.

## Entering BIOS Setup Program

1. Turn on or restart your computer.
2. Press <F2> at the Dell logo to enter BIOS setup program.

 **NOTE:** If you wait too long and the operating system logo appears, continue to wait until you see the Windows desktop, then restart your computer and try again.

# Resetting BIOS Password

BIOS passwords are used to add extra security to computers. You can configure your computer to prompt for a password when booting or when entering BIOS setup program.

Use one of the following methods, depending on your computer type, to reset lost or forgotten BIOS passwords.

 **CAUTION:** Resetting the BIOS password involves clearing all data from the CMOS. If you have changed any BIOS settings, you must make those changes again after resetting the password.

## Remove the CMOS Battery

 **WARNING:** Read the safety instructions before working inside your computer.

Almost all motherboards use a coin-cell battery that helps retain BIOS settings, including the password. To reset the password, remove the coin-cell battery, wait 15-30 minutes, and then replace the coin-cell battery.

 **NOTE:** For more information on the location of the coin-cell battery and instruction on removing and replacing it, see the *Service Manual* at [dell.com/support](http://dell.com/support).

## Use System-Board Jumper

Almost all system boards on desktop computers contain a jumper to clear CMOS settings along with the BIOS password. The location of this jumper varies depending upon the system board. Look for the jumpers near the CMOS battery, usually labeled as CLR, CLEAR, CLEAR CMOS and so on.

There are 3 pins. The jumper joins the centre pin to either the left or right pin. Remove the jumper and join the centre pin to the opposite pin. Wait for a few seconds then remove the jumper and join the centre pin to original pin.

 **WARNING:** Read the safety instructions before working inside your computer.

 **NOTE:** For more information on location of the jumper and working inside your computer, see the *Service Manual* at [dell.com/support](http://dell.com/support).

# Changing the Boot Sequence

You may need to change the boot sequence to boot from a device other than your default device, for example when reinstalling the operating system or, using a recovery disc or USB drive.

You can select the boot order using the Boot Menu or the BIOS setup program.

## Using Boot Menu

Use the Boot Menu to change the boot sequence of your computer for the current boot. Your computer boots from the selected device only for the current boot and returns to the default device next time you reboot your computer.

To select a boot device using the Boot Menu:

1. Turn on or restart your computer.
2. Press <F2> at the Dell logo to enter BIOS setup program.
  -  **NOTE:** If you wait too long and the operating system logo appears, continue to wait until you see the Windows desktop, then restart your computer and try again.
3. Use the up-arrow or down-arrow keys to select the device you want to boot from and press <Enter> or press the number displayed next to the boot device.

## Using BIOS Setup Program

Use BIOS setup program to select the order of devices your computer uses to boot every time.

To change the boot sequence using BIOS setup program:

1. Enter BIOS setup program.
2. Select the **Boot** tab.
3. Select the check boxes to enable or disable the devices to be used for booting.
4. Move the devices up or down to change the boot sequence.

 **NOTE:** The first device in the list is the default boot device.

# Getting Help and Contacting Dell

---

## Getting Help

You can get information and help on Dell products and services using these online self-help resources:

### Self-Help Information

Accessing Windows Help and Support

For more information about Dell products and services

For troubleshooting information, user manuals, technical help blogs, driver, software updates, and so on

For more information about your Microsoft Windows operating system

### Self-Help Options

#### Windows 8.1

Open the Search charm, type **Help and Support** in the search box and press <Enter>.

#### Windows 7

Click **Start**  → **Help and Support**.

**dell.com**

**dell.com/support**

**microsoft.com**

## Contacting Dell

To contact Dell for sales, technical support, or customer service issues, see **dell.com/contactdell**.

 **NOTE:** Availability varies by country and product, and some services may not be available in your area.

 **NOTE:** If you do not have an active Internet connection, you can find contact information on your purchase invoice, packing slip, bill, or Dell product catalog.

# References

---

## Computer Maintenance

It is recommended that you perform the following tasks to avoid general computer problems:

- Provide direct access to a power source, adequate ventilation, and a level surface to place your computer.
- Do not block, push objects into, or allow dust to accumulate in the air vents.
- Back up your data regularly.
- Perform a virus scan regularly.
- Check your computer for errors using My Dell and other tools available on your computer.
- Clean your computer regularly using a soft, dry cloth.

△ **CAUTION: Using water or other solvents to clean your computer may damage your computer.**

- Ensure that there is enough free space on your internal hard drive. Not having enough free space may result in degraded performance.
- Enable automatic Windows and other software updates to address software issues and improve computer security.

## Power Management

Power management helps you reduce the electricity consumption of your computer by regulating power supply to the various components. The BIOS setup program and the operating system allow you to configure when the power supply to certain components should be reduced or cut off.

Some common power-saving states in Microsoft Windows are:

- **Sleep** — Sleep is a power-saving state that allows a computer to quickly resume full-power operation (typically within a few seconds) when you want to start working again.
- **Hibernation** — Hibernation puts your open documents and programs on your hard disk, and then turns off your computer.

- **Hybrid sleep** — Hybrid sleep is a combination of sleep and hibernation. It puts any open documents and programs in memory and on your hard disk, and then puts your computer into a low-power state so that you can quickly resume your work. When hybrid sleep is turned on, putting your computer into sleep automatically puts your computer into hybrid sleep.
- **Shut down** — Shutting down your computer helps when you are not planning to use the computer for a considerable period of time. It helps keep the computer secure and also saves more energy. Shut down your computer before adding or removing hardware inside the computer. Shutting down is not a recommended when you need to resume work quickly.

## Configuring Power Settings

To configure the power settings:

### Windows 8.1

1. Right-click anywhere on the Start screen.
2. Click **All apps** at the bottom-right corner of the screen.
3. Under **Windows System**, click **Control Panel**.
4. If your Control Panel is displayed by Category, click the **View by:** drop-down and select **Small icons** or **Large icons**.
5. Click **Power Options**.
6. You can choose from a plan from the list of options available depending on your computer usage.
7. To modify the power settings, click **Change plan settings**.

### Windows 7

1. Click **Start**  → **Control Panel** → **Power Options**.
2. You can choose from a plan from the list of options available depending on your computer usage.
3. To modify the power settings, click **Change plan settings**.

## Configuring the Power Button Behavior

To configure the power button behavior:

### Windows 8.1

1. Right-click anywhere on the Start screen.
2. Click **All apps** at the bottom-right corner of the screen.
3. Under **Windows System**, click **Control Panel**.
4. If your Control Panel is displayed by Category, click the **View by:** drop-down and select **Small icons** or **Large icons**.
5. Click **Power Options**. Choose what you want your computer to do when you press the power button from the drop-down menu next to **When I press the power button**.  
You may choose different option when your computer is running on battery and when it is connected to a power adapter.
6. Click **Save changes**.

### Windows 7

1. Click **Start**  → **Control Panel** → **Power Options**.
2. Click **Choose what the power buttons do**.
3. Choose what you want your computer to do when you press the power button from the drop-down menu next to **When I press the power button**.  
You may choose different option when your computer is running on battery and when it is connected to a power adapter.
4. Click **Save changes**.

## Improving Battery Life

The operating time of a battery, which is the time the battery can hold a charge, varies depending on how you use your laptop computer.

The operating time of your battery significantly reduces if you use:

- Optical drives.
- Wireless communication devices, ExpressCards, media cards, or USB devices.
- High-brightness display settings, 3D screen savers, or other power-intensive programs like complex 3D graphics applications and games.



You can improve the battery performance by:

- Operating the computer on AC power when possible. Battery life reduces with the number of times the battery is discharged and recharged.
- Configuring the power management settings using Microsoft Windows Power Options to optimize your computer's power usage (see "[Power Management](#)").
- Enabling the Sleep/Standby and Hibernation features of your computer.

 **NOTE:** The life of the battery decreases over time depending on how often the battery is used and the conditions under which it is used.

You can configure the battery-charging behavior to increase the battery life.

### Dell Longevity Mode

Frequently connecting and disconnecting your computer to a power source without allowing the battery to fully discharge may reduce battery life. The longevity mode feature protects the battery health by moderating the extent to which your battery charges, and prevents your battery from frequent charge and discharge cycles.

Your Dell laptop automatically monitors the charging and discharging behavior of your battery, and if applicable, displays a message requesting you to enable longevity mode.

 **NOTE:** Dell longevity mode may not be supported on all laptops.

To configure Dell longevity mode:

1. Right-click the battery icon on the Windows notification area and click **Dell Extended Battery Life Options**.  
The **Battery Meter** dialog box appears.
2. Click the **Longevity mode** tab.
3. Click **Enable** to turn on, or **Disable** to turn off Dell longevity mode.
4. Click **OK**.

 **NOTE:** When longevity mode is enabled, the battery charges only between 88% – 100% of its capacity.

## Dell Desktop Mode

If you primarily use your computer with the power adapter connected, you can enable the desktop mode to moderate the extent to which your battery is charged. This reduces the number of charge/discharge cycles and improves battery life.

Your Dell laptop automatically monitors the charging and discharging behavior of your battery, and if applicable, displays a message requesting you to enable Desktop Mode.

 **NOTE:** Dell desktop mode may not be supported on all computers.

To enable or disable desktop mode:

1. Right-click the battery icon on the Windows notification area, and then click **Dell Extended Battery Life Options**. The **Battery Meter** dialog box is displayed.
2. Click the **Desktop mode** tab.
3. Click **Enable** or **Disable** based on your preference.
4. Click **OK**.

 **NOTE:** When desktop mode is enabled, the battery charges only between 50% – 100% percent of its capacity.

## Migration Tips

Computer migration is the moving of data and applications between two different computers. The most common reasons requiring a computer migration are when you purchase a new computer or when you upgrade to a new operating systems.

 **CAUTION:** While there are several utilities that simplify migration, it is recommended that you backup your files like pictures, music, documents, and so on.

## Migrating from one Windows Operating System to a newer Operating System

While migrating to a newer operating system, refer to the Microsoft guidelines provided for migration from one operating system to another. See [www.microsoft.com](http://www.microsoft.com) for details.

# Ergonomic Instructions

△ **CAUTION: Improper or prolonged keyboard use may result in injury.**

△ **CAUTION: Viewing the monitor screen for extended periods of time may result in eye strain.**

For comfort and efficiency, use the ergonomic guidelines when setting up and using your computer.

Laptops are not necessarily designed for continuous operation as office equipment. If you intend to use your laptop continuously, it is recommended that you connect an external keyboard.

- Position your computer so that the monitor and keyboard are directly in front of you as you work. Special shelves are available (from Dell and other sources) to help you correctly position your keyboard.
- Place the external monitor at a comfortable viewing distance. The recommended distance is 510 mm–610 mm (20 in–24 in) from your eyes.
- Ensure the monitor is at eye level or slightly lower when you are sitting in front of the monitor.
- Adjust the tilt of the monitor, its contrast and brightness settings, and the lighting around you (such as overhead lights, desk lamps, and the curtains or blinds on nearby windows) to minimize reflections and glare on the monitor screen.
- Use a chair that provides good back support.
- Keep your forearms horizontal with your wrists in a neutral, comfortable position while using the keyboard or mouse.
- Always leave space to rest your hands while using the keyboard or mouse.
- Let your upper arms hang naturally at your sides.
- Sit erect, with your feet resting on the floor and your thighs level.
- When sitting, ensure the weight of your legs is on your feet and not on the front of your chair seat. Adjust your chair's height or use a footrest, if necessary, to maintain proper posture.
- Vary your work activities. Try to organize your work so that you do not have to type for extended periods of time. When you stop typing, try to do things that use both hands.
- Keep the area under the desk clear of obstruction and cables or power cords that may interfere with comfortable seating or present a potential trip hazard.

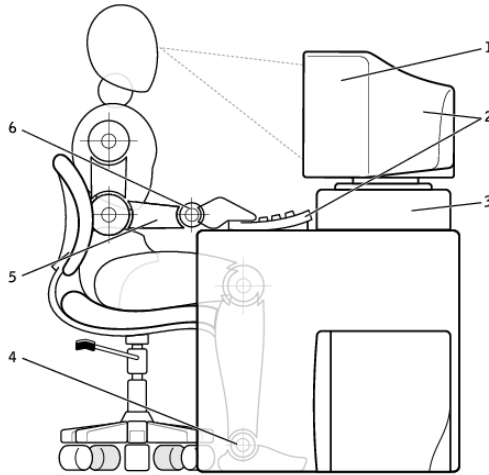

- |   |   |   |                         |
|---|---|---|-------------------------|
| 1 | monitor at or below eye level                                 | 4 | feet flat on the floor  |
| 2 | monitor and keyboard positioned directly in front of the user | 5 | arms at desk level      |
| 3 | monitor stand   | 6 | wrists relaxed and flat |

 **NOTE:** For the latest ergonomic instructions, see [dell.com/regulatory\\_compliance](https://dell.com/regulatory_compliance).

## Dell and the Environment

Green is not about limitation, it's about possibility. It's about finding a better way.

Every day, you have the opportunity to make greener choices, but when choosing technology, you do not want to compromise on cost, performance or reliability. At Dell, we believe you shouldn't have to, which is why we strive to ensure that people and companies don't have to make trade-offs to be green.

We make this a reality by delivering practical products and services that make an impact on real environmental issues, because at the heart of green is the powerful idea that better ways are possible. Better ways to use time, money and resources. Better ways to live, work and succeed in our world.



---

### **Bamboo — Nature's Eco-Friendly Packaging Solution**

To help achieve the shared goal of finding new ways to help preserve our planet's natural resources, Dell provides practical, but innovative packaging solutions that help minimize environmental effects. Less packaging means less hassle for customers. Recyclable packaging makes it easy to dispose. And sustainable materials are good for our planet.

Bamboo packaging is used to ship several Dell products.

For easy disposal, our bamboo packaging is biodegradable and certified 'compostable' by the Soil Control Lab

We know that responsible sourcing is important to you, so our bamboo is sourced from a forest far away from pandas' known habitats.



### **Join the Plant a Tree Program**

Dell created the Plant a Tree program to make it easy for you to offset the greenhouse gas emissions from your computer equipment and to help build a healthier planet — one tree and forest at a time.



### **Recycle With Dell**

As you upgrade computers and electronics, please join our efforts to keep technology out of the world's landfills. Recycling your home and business computers with us is fast, convenient and secure. Do yourself and your planet a favour. Dispose of your technology responsibly with Dell.

---

# Regulatory Compliance Policy

For complete details, visit [dell.com/regulatory\\_compliance](https://dell.com/regulatory_compliance).

## Contact Details for Regulatory Compliance Web site

For any questions related to Product Safety, EMC or Ergonomics, send an e-mail to [Regulatory\\_Compliance@dell.com](mailto:Regulatory_Compliance@dell.com).

## Additional Compliance Information

The World Wide Trade Compliance Organization (WWTC) is responsible for managing Dell's compliance to import and export regulations, including product classification. Classification data for Dell manufactured systems is provided within the product-specific, system Product Safety, EMC and Environmental Datasheet.

For any questions related to import or export classification of Dell products, send an e-mail to [US\\_Export\\_Classification@dell.com](mailto:US_Export_Classification@dell.com).